

RESTRICTED

AAF MANUAL 51-127-1

TRANSPORTATION  
LIBRARY

TL  
686  
.L82  
U58  
1945

PILOT TRAINING MANUAL FOR THE

*Lightning*

P-38

HEADQUARTERS, ARMY AIR FORCES

RESTRICTED

WILLIAMS PUBLISHING CO.  
1945. 7-30-45+2,500

Digitized by Google  
THE UNIVERSITY OF MICHIGAN LIBRARIES

# PILOT TRAINING MANUAL FOR THE LIGHTNING

# P-38

This revised edition supersedes the original (brown cover) Pilot Training Manual for the Lightning. All copies of the latter are rescinded.

Headquarters Army Air Forces  
Washington 25, D. C., 1 Aug 1945

The use and authentication of this manual are governed by the provisions of AAF Regulation 50-17.

BY COMMAND OF GENERAL ARNOLD:



Ira C. Eaker  
Lieutenant General, United States Army  
Deputy Commander, Army Air Forces

Additional copies of this manual should be requested from:  
Hq. AAF, Office of Flying Safety, Safety Education Division,  
Winston-Salem 1, North Carolina

INITIAL DISTRIBUTION REVISED EDITION:

HEADQUARTERS AAF, AAF TRAINING COMMAND, 3RD AIR FORCE, 4TH AIR FORCE

RESTRICTED

1

Transportation  
Library

TL  
686  
.L82  
U58  
1945



# *Introduction*

**This manual is the text for your training as a P-38 pilot. The Air Forces' most experienced training and supervisory personnel have collaborated to make it a complete exposition of what your duties as a pilot are, how each duty will be performed, and why it must be performed in the manner prescribed.**

**The techniques and procedures described in this book are standard and mandatory. In this respect the manual serves the dual purpose of a training checklist and a working handbook. Use it to make sure that you learn everything described herein. Use it to study and review the essential facts concerning everything taught. Such additional self-study and review will not only advance your training, but will alleviate the burden of your already overburdened instructors.**

**This training manual does not replace the Technical Orders for the airplane, which will always be your primary source of information concerning the P-38 so long as you fly it. This is essentially the textbook of the P-38. Used properly, it will enable you to utilize the pertinent Technical Orders to even greater advantage.**



Handwritten signature of K. H. Arnold, Commanding General, Army Air Forces.

COMMANDING GENERAL, ARMY AIR FORCES



# SECTION 1 *Meet the Lightning*

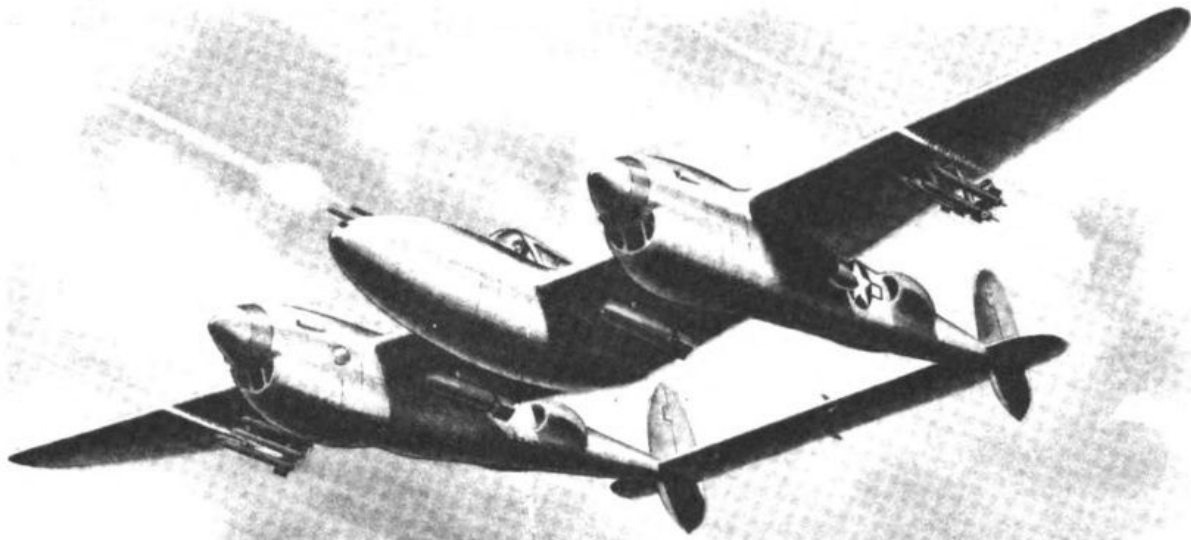

## HISTORY

In the spring of 1937 the United States Army Air Corps submitted to various manufacturers specifications for a high altitude fighter airplane.

To fill these requirements of performance, armament, and adaptability, the Lockheed Aircraft Corporation embarked on the construction of a radically different model, later designated the XP-38.

This highly experimental model was completed and ready for test in December of 1938. Lt. Ben Kelsey, pilot and engineer, was given

the dubious honor of testing the new airplane. One night late in December, the XP-38 was dismantled and transported by trucks to March Field. By the middle of January, 1939, Kelsey began the conventional ground tests.

Even then numerous rumors had started concerning the future of the XP-38. Its twin booms and tricycle landing gear certainly deviated from the conventional. These, coupled with two engines and dual engine controls, appeared to be too much for one man to handle, according to the hangar talk. The brakes failed during a fast taxi run, and heads nodded an "I told you so." Undaunted, Kelsey carried on and a few days later was ready for the first takeoff.

RESTRICTED

5

## RESTRICTED

Again the hangar boys wagged their heads when the XP started a violent shaking as it became airborne on its first takeoff. Thanks to Kelsey's skill the XP continued to fly—a whole half hour. The ailment was corrected and subsequent test flights were made.

Early in February, the XP left on a cross country flight to Wright Field where a brief check would decide its acceptability. It made the hop from March Field to Wright Field in 5 hours and 33 minutes flying time. Kelsey had a brief conference with General Arnold, and then took off for Mitchel Field, N. Y. Forty-two minutes later the XP made the headlines by cracking up in a creek 200 yards from Mitchel Field.

Discouraged, but not quitting, the manufacturers started the YP-38, the first of 13 for the U.S. Army Air Corps.

The YP, like its predecessor the XP, made the headlines—and in a detrimental fashion. Eventually it became common knowledge, as any Southern California citizen could testify, that the "Yippy" was a jinx airplane.

The pilot was a doomed man if anything went wrong. He could not bail out, the tail had a nasty habit of shaking off, and the plane could not be pulled out of a dive.

The British and French, hard pressed for airplanes, contracted to purchase more than 600 P-38's. They specified certain modifications. They insisted that there be no turbo-superchargers or counter-rotation propellers. As expected, the airplane gave a very poor performance. Again the insults grew. It seemed as if the P-38 was doomed to die a dishonorable death.

A small nucleus of factory and Army men, including Kelsey, never lost faith. The manufacturer continued production with original designs.

Training new pilots for the airplane was slow. It was a lot of airplane to step into and take up alone. All was not lost, however. The manufacturer came to the rescue, and, with the sanction of General Giles, Jimmie Mattern introduced the "Piggyback" as a training aid. The Piggyback, probably one of the greatest single training aids, tremendously increased the efficiency of the training program. It did much to dispel numerous baseless rumors about the P-38.

The tempo of training and producing fighter pilots for the airplane kept increasing. Yet the crucial test of meeting and bettering the enemy had yet to come.

First contact with the enemy was made in the Aleutians, August 4, 1942. Two P-38's met and shot down three type 97 Japanese flying boats. Ten days later, over Iceland, a P-38 shot down a Focke-Wolf Kurier. The christening had occurred. The skeptics claimed this proved nothing. Several weeks later over France, the Lightnings were unable to make contact with the enemy, and again the skeptics had a chance to gloat.

Fate finally relented, and in November 1942 the P-38 received its real test in the North African invasion. Taking the Luftwaffe on under all conditions, the black sheep became a white hope—the queen of the African skies. The same excellent reports poured in from the Aleutians, and the Southwest Pacific. It was in the Southwest Pacific that 12 P-38's without loss to themselves disposed of 15 Zeros. Said one bewildered Jap pilot: "Two airplanes—one pilot!"

The P-38 had won its spurs. It became the darling of the bomber boys for bringing them home. New fields were tried—all with the same success. Dive-bombing, skip-bombing, and strafing became part of the day's work for "The Forked Devil," as the men of the Luftwaffe called the Lightning.

The P-38 not only dishes it out; it can take it:

A few recorded cases: Captain Hoelle clipped a telephone pole while strafing. His ship was horribly battered, but he came back.

One lad lost an engine 5 times over Kiska but made it home each time.

A P-38 pilot left 3 feet of wing on a Jap destroyer and brought his plane back.

Jack Illfrey flew home on one engine with 2 holes in the good propeller and 168 holes in his airplane.

Here's how Lt. Ben Kelsey describes the P-38: "This comfortable old cluck will fly like hell, fight like a wasp upstairs, and land like a butterfly." He adds: "As a fighting ship it's just like a big girl and you have to take her up on your lap and manhandle her. It's an extremely honest airplane; it doesn't bite and doesn't do unexpected things."



## COMBAT EXPERIENCE

The reputation of a fighter airplane depends on the destruction it deals out to the enemy, the protection it gives the pilot, and the way the men who fly it feel about it. They must be convinced that their plane is the best in the world.

The P-38 is a leading fighter of World War II. It has a very long range, enabling it to give bomber support deep into enemy territory. It fights equally well at high or low altitudes. The P-38 is also a fighter bomber, capable of carrying 2 tons of bombs.

Its four .50-cal. machine guns and one 20-mm. cannon, all mounted in the nose, produce a concentration of fire power ideal for strafing. The safety factor of 2 engines has endeared it to fighter pilots who call the second engine their "round trip ticket." With one engine knocked out, P-38 pilots in combat have finished the fight and made it home.

The P-38 has demonstrated a remarkable adaptability. It has met the enemy on all fronts, coping equally well with the changing needs of different situations.

RESTRICTED

### High altitude fighter

Two turbo-superchargers give the Allison engines sea level horsepower at extremely high altitudes. The success of the P-38 as a high altitude escort over Europe and as a high altitude interceptor in the Southwest Pacific area has established an enviable combat record.

### Low altitude fighter and fighter-bomber

Sweeping in at mast height, P-38's have sunk many German, Italian, and Japanese ships. The presence of all the guns in the nose, rather than the wings, eliminates criss-crossing cones of fire. It has an effective straight-ahead range of more than 600 yards, making it excellent for strafing.

A flight of P-38's can go into action with all guns blazing while at the same time carrying a bomb load capable of sinking the largest vessels. The P-38 has won fame as a dive bomber and skip bomber in every theatre of war in addition to its other successes.

### Escort fighter

Carrying droppable fuel tanks, the P-38 has a range of more than 1000 miles. It was the first fighter to fly the Atlantic and can be ferried to any fighting front. It was also the first fighter to go all the way with bombers on long range missions.

### Photo-reconnaissance

The photo-reconnaissance version of the Lightning is known as the F-5. Instead of the usual 4 machine guns and 1 cannon, the F-5 has three types of cameras used in six different arrangements. Its pilot can take pictures straight down and obliquely.

Pilots who fly F-5's come in sometimes at tree-top height, take their pictures, and are gone before enemy anti-aircraft guns can be trained on them. Or again, they come over at 30,000 feet and take pictures so clear that you can pick out automobile tire tracks in the enlarged prints. Unarmed, and generally alone, these F-5's, because of their great range and tremendous speed, are among the finest photo-reconnaissance ships in the world.



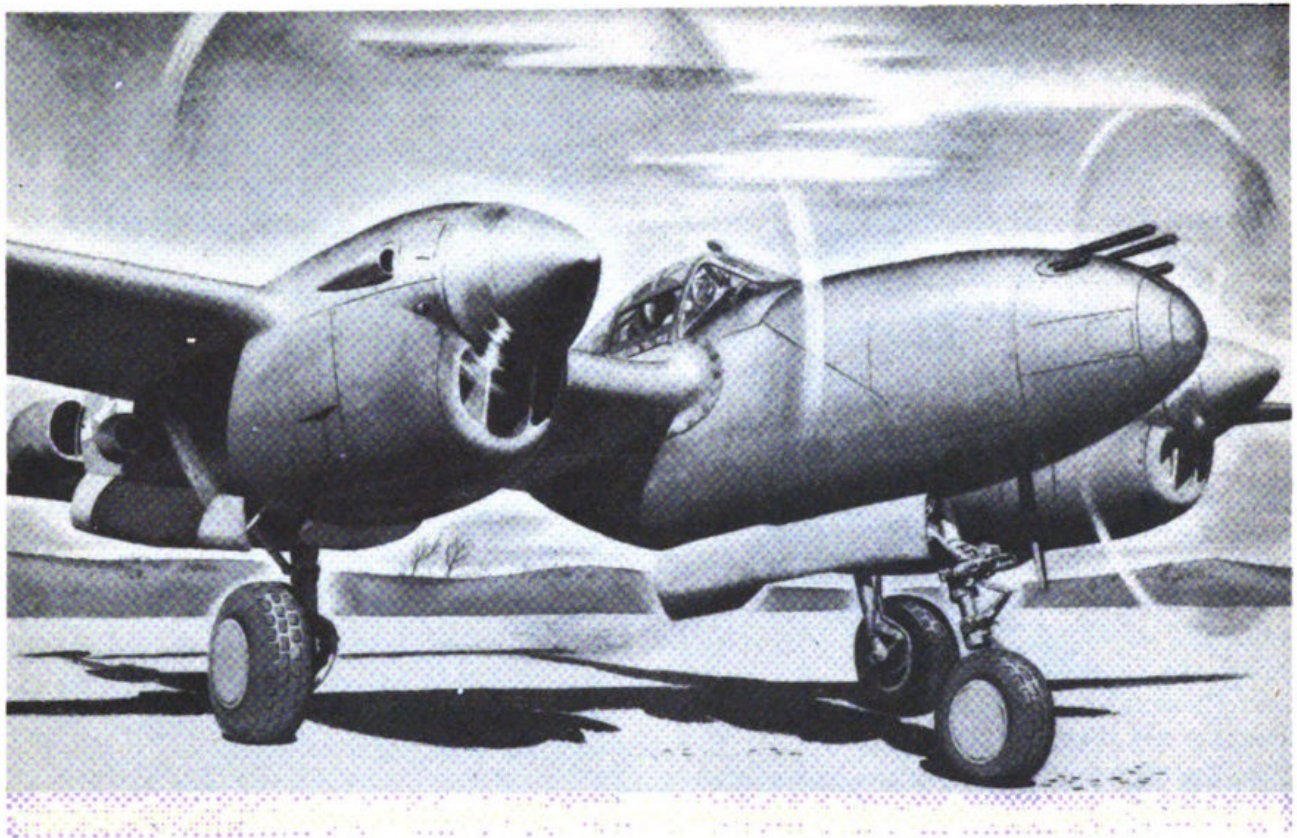

## GENERAL DESCRIPTION

"Boy, that's a lot of airplane!"

The P-38 is a big fighter plane. It stands almost 10 feet high, spreads out 52 feet, and is over 37½ feet long.

When the impression of size ceases to be a novelty, you notice some rather peculiar looking features. The long slender booms tapering into twin rudders are unique in aircraft design.

A closer inspection from the front quarter shows that the P-38 is a midwing airplane, with 2 liquid-cooled engines and 2 three-bladed propellers. It has a streamlined center section, called a gondola, and stands solidly on a tricycle landing gear. There are four .50-cal. machine guns and one 20-mm. cannon in the nose.

Right under the wing between the engines and the gondola, you can see two odd projections. They are shackles for external tanks or bombs. The plane can carry quite a payload on these shackles.

As you turn around to the right of the airplane, the slender profile comes into view. The clean lines of the boom are broken in 3 places. On the forward portion of the boom, right under the wing, is a large tear-shaped ram air intake. Just behind the wing and on top of the boom is the turbo-supercharger. In the center of the boom is the prominent coolant radiator and shutter.

Continuing around to the rear, you see the horizontal stabilizer and the elevator with its counterweights for dynamic stability. Looking over the tail section, you have a good rear view of the plexiglas enclosure of the cockpit.

The P-38 is a most impressive looking airplane. You wonder if you can handle it, but you needn't worry. With a little time and application on your part, and whether you fire guns or cameras, the P-38 will become a formidable weapon in your hands.

**DIMENSIONS AND DATA**

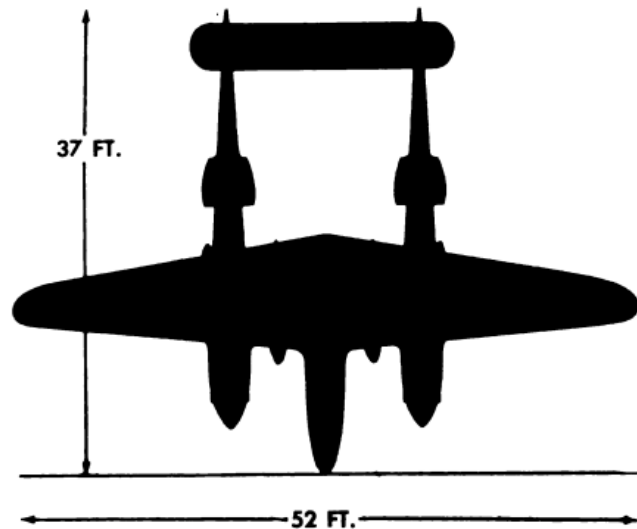

Wing area . . . . .	327.5 sq. ft.
Wing loading . . . . .	49 lb. sq. ft.
Gross weight (combat) . . . . .	16,000 lbs.
Center of gravity limits . . . . .	forward—20.00% M.A.C. aft —32.00% M.A.C.
Aspect ratio . . . . .	8.26:1
Maximum speed . . . . .	over 420 mph
Operational ceiling . . . . .	30,000 feet
Armament . . . . .	Four .50 cal. machine guns. One 20 mm. cannon. Installations to carry 10 rockets. Installations to carry 2 bombs up to 2000 lbs each.

**P-38 AND F-5 SERIES COMPARISON**

XP-38		P-38G-10 . . . . .	F-5A-1
YP-38			F-5A-3
P-38			F-5A-10
P-38D		P-38G-15 . . . . .	P-322
P-38E . . . . .	F-4	P-38H-1	
	F-5-1	P-38H-5	
P-38F		P-38J-1	
P-38F-1 . . . . .	F-4A	P-38J-5	
P-38F-5		P-38J-10 . . . . .	F-5B-1
P-38F-13 . . . . .	P-322	P-38J-15 . . . . .	F-5C-2
P-38F-15 . . . . .	P-322	P-38J-20 . . . . .	F-5E-4
P-38G-1		P-38J-25 . . . . .	F-5E-4
P-38G-3		P-38L-1 . . . . .	F-5E-4
P-38G-5		P-38L-5 . . . . .	F-5G-6

RESTRICTED

## INSTRUCTION PRIOR TO FIRST FLIGHT

Study and understand all the Technical Orders pertaining to the P-38. Every P-38 series is different. An experienced pilot of a P-38G must have the proper cockpit time before he flies a P-38L or any other series. There are many modifications, relocations of controls, and differences in operation that he must know.

Read your Pilots' Information File, AAF Flying Regulations, and your Base Flying Regulations.

### Cockpit Explanation

Your Flight Leader will give you a complete cockpit explanation. The explanation will include the location and operation of all instruments, switches, and controls.

### Cockpit Time

Cockpit time is your introduction to the P-38. Take advantage of it. Rehearse procedures. Read and re-read the checklists.

You will spend a minimum of 5 hours in the cockpit of the P-38 series you are going to fly. Study all the instruments and cockpit installations. Become so well acquainted with every instrument and control that you are at home in the cockpit on your first solo flight and are prepared for any emergency.

The necessity for developing a thorough cockpit routine cannot be overemphasized. Hit-and-miss skipping about the cockpit results in

forgetting some essential check. **Always check the cockpit from left to right.** Use the checklist.

### Blindfold Test

You are required to pass a blindfold test. Blindfolded, you have to locate and operate all instruments, switches, and controls. This is when well spent cockpit time pays dividends.

Make a cockpit check before starting, after starting, before takeoff, in flight, before landing, and after cutting the engines.



## PIGGYBACK DEMONSTRATION

After five hours' cockpit time, you receive a demonstration flight in a piggyback P-38. Make every minute of this ride count. Know what the instructor is doing from the time you both enter the cockpit until the flight is over and the engines are cut off.

### Piggyback Bailout Procedure

The first thing you do after you and the pilot are in the piggyback is rehearse the recommended piggyback bailout procedure. You'll know then, before takeoff, how to leave the airplane in case it's necessary to bail out.

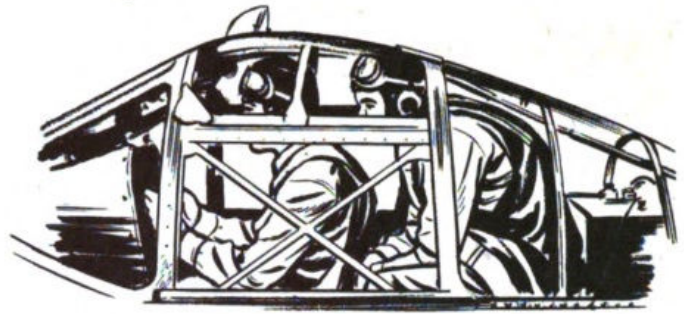

As a passenger you wear a B-8 or B-10 back-type parachute. In an emergency, you leave first and the pilot follows. If you are too large to leave while the pilot is in the cockpit, you hold the control wheel as the pilot leaves and then go out after him.

## The Demonstration and What to Look For

**Demonstration:** Power-off and power-on stalls, gear and flaps up and down.

**Look for** : Indications on hydraulic pressure gage during gear operation and attitude of airplane and indicated airspeeds during stalls.

**Demonstration:** Accelerated stalls at high and low airspeeds.

**Look for** : Characteristic buffeting and recovery by easing pressure on control wheel.

**Demonstration:** Tight turns, with and without the use of combat maneuver flaps.

**Look for** : Maneuverability and effectiveness of combat maneuver flaps.

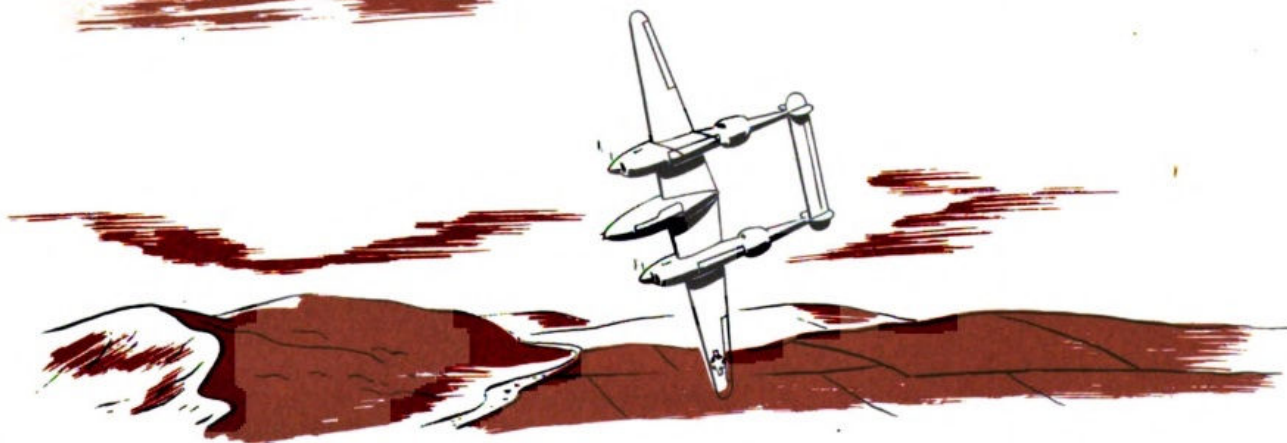
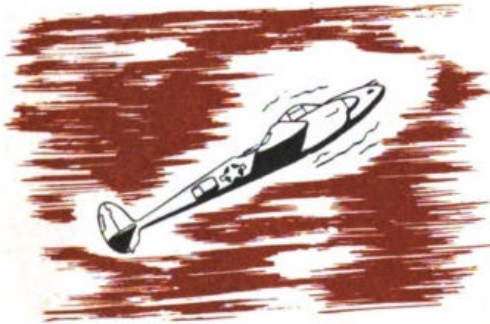

# ACROBATICS IN THE PIGGYBACK

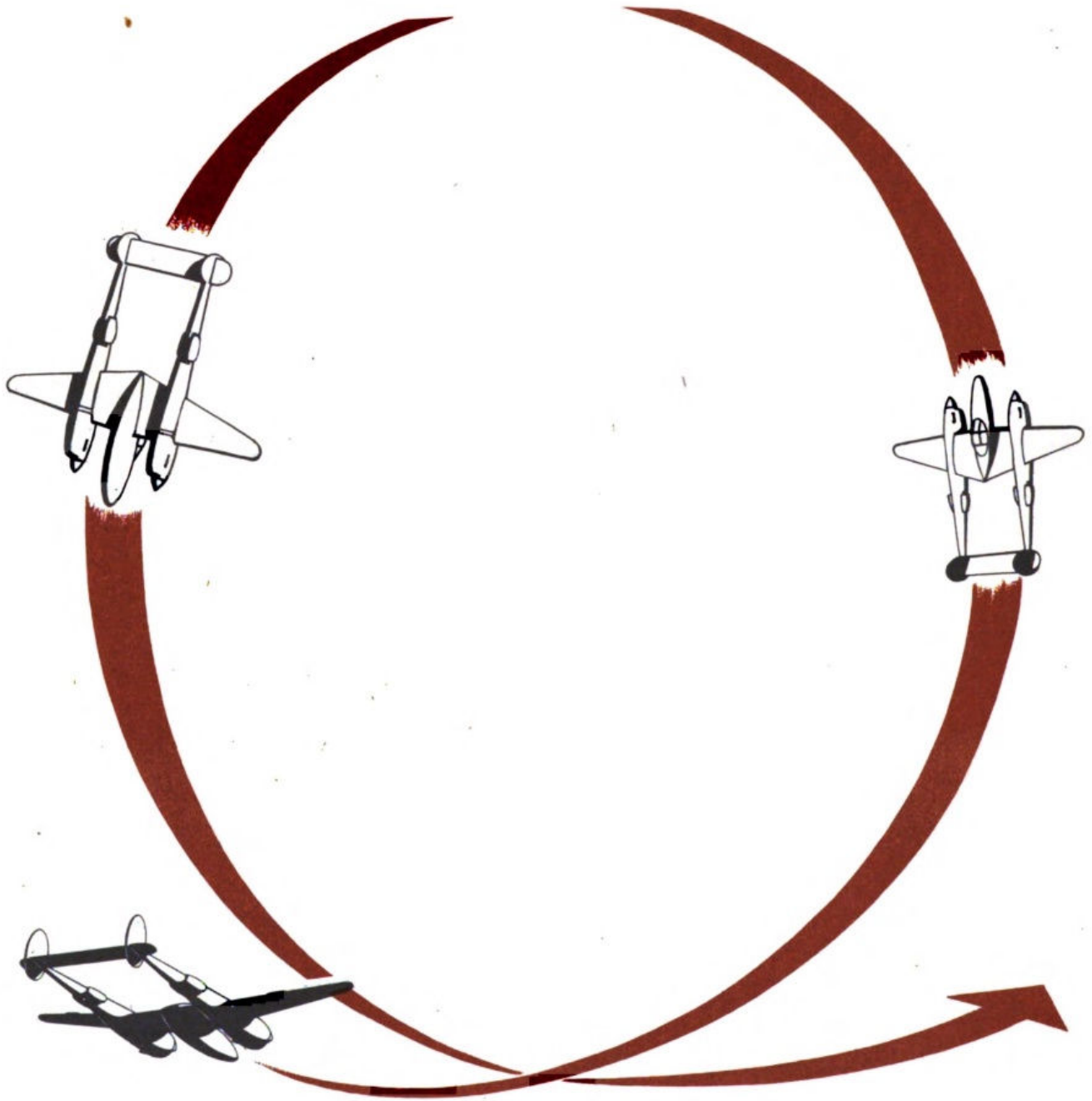

**Demonstration: Loop**  
**Look for : Ease of Performance**

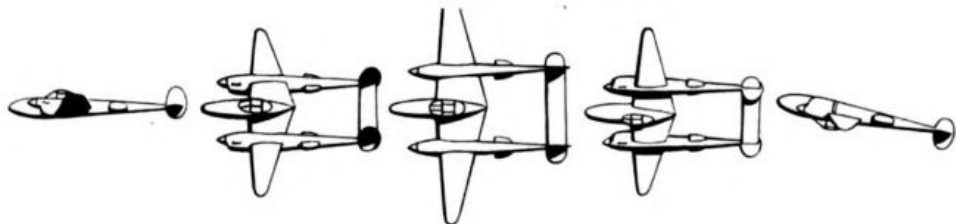

**Demonstration: Immelmann**  
**Look for : Maneuverability**

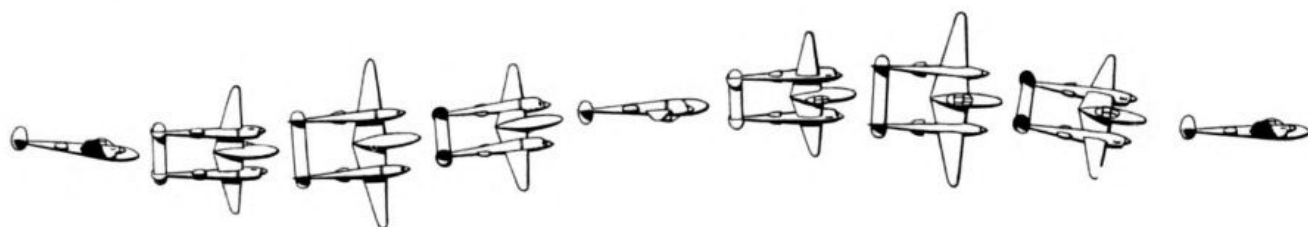

**Demonstration: Slow roll**  
**Look for : Accuracy and technique**

*Note* THIS MANEUVER IS ALWAYS DONE TO THE LEFT. A SLOW ROLL TO THE RIGHT CAN CAUSE THE NOSEWHEEL DOOR TO POP OPEN AND BREAK OFF.

## RESTRICTED

**Demonstration:** Simulated engine failure after takeoff. This is performed at a minimum altitude of 5000 feet above the ground. Actual takeoff conditions are simulated by reducing the airspeed to 130 mph, lowering the landing gear, and assuming the indicated altitude to be ground level. Takeoff manifold pressure and rpm is applied, gear retracted, and a climb begun.



**Look for** : Simulated takeoff conditions. Simulated engine failure achieved by closing one throttle. Initial yaw when the power of one engine is lost, and the standard single engine procedure that follows:

1. Directional control maintained by reducing power of live engine as much as necessary. The yaw is corrected by rudder and as much power from the live engine is added that can be held with rudder.
2. Release drop tanks or bombs (this is done only in an actual emergency).
3. Rudder trimmed to relieve pressure.
4. Mixture control of throttled engine moved to IDLE CUT-OFF.
5. Propeller feathered.
6. Fuel booster pump OFF.
7. Coolant and oil shutters of dead engine closed.

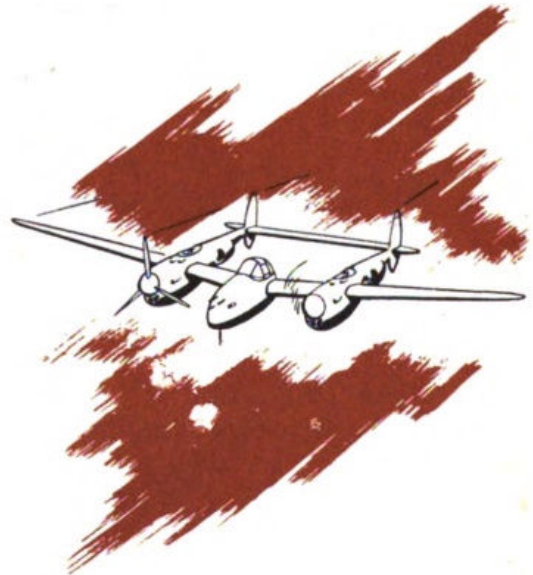

*Note:* This demonstration will be done with booster pumps OFF. Fuel selector and ignition are not to be turned OFF.

**RESTRICTED**

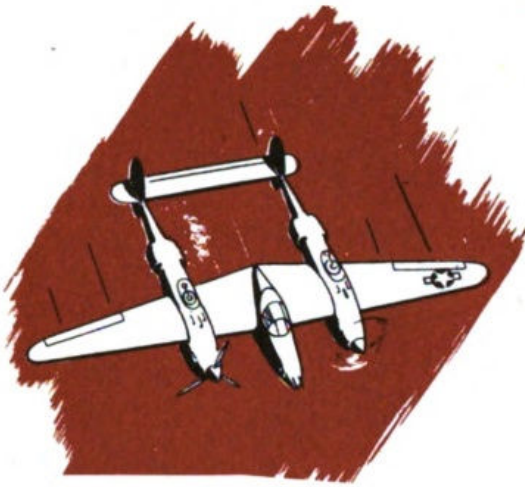

**Demonstration:** Single engine dive at 300 mph and single engine turns, shallow and steep, to right and left.

**Look for** : Ease of handling and excellent single engine performance.

**Demonstration:** Unfeathering propeller and restarting engine.

**Look for** : Procedure.

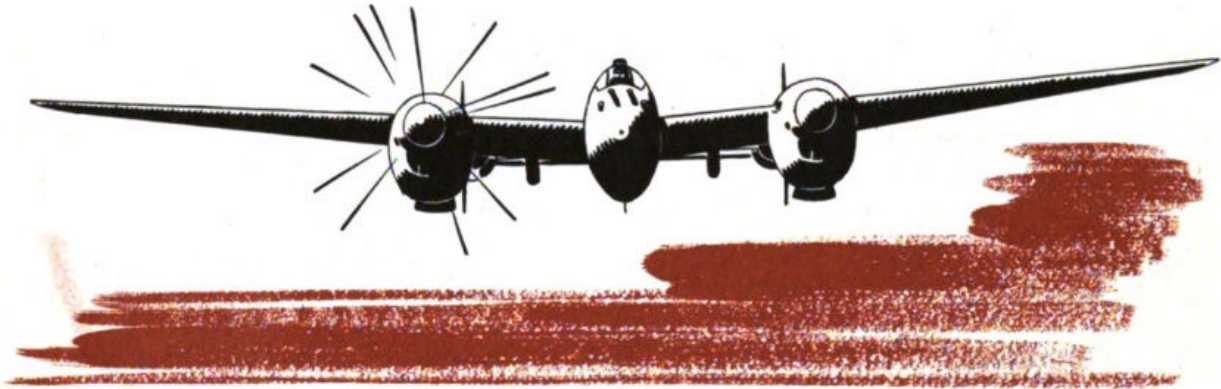

**Demonstration:** Operation of Curtiss electric propellers.

**Look for** : Difference between automatic and manual operation.

**Demonstration:** Normal approach and landing.

**Look for** : Pattern, altitude and airspeeds.



**RESTRICTED**

**15**



# SECTION 2 *Equipment*

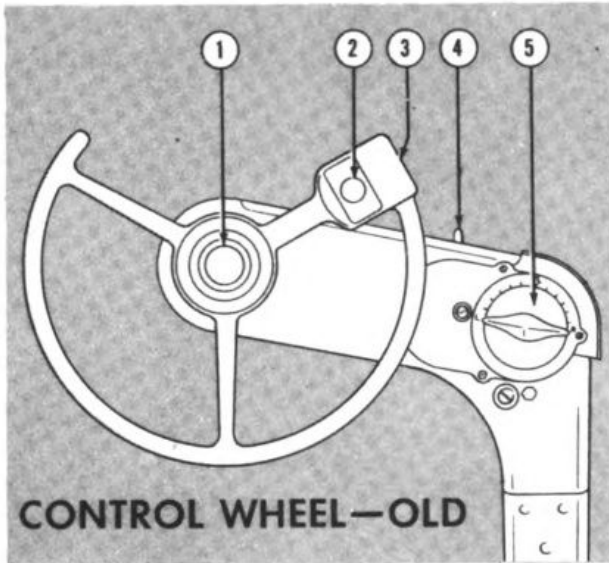

CONTROL WHEEL—OLD

1. Radio transmitter button.
2. Cannon trigger button.
3. Machine gun trigger button (back of wheel).
4. Gun-camera selector switch.
5. Aileron trim tab control. P-38's with aileron boost do not have an aileron trim tab control.

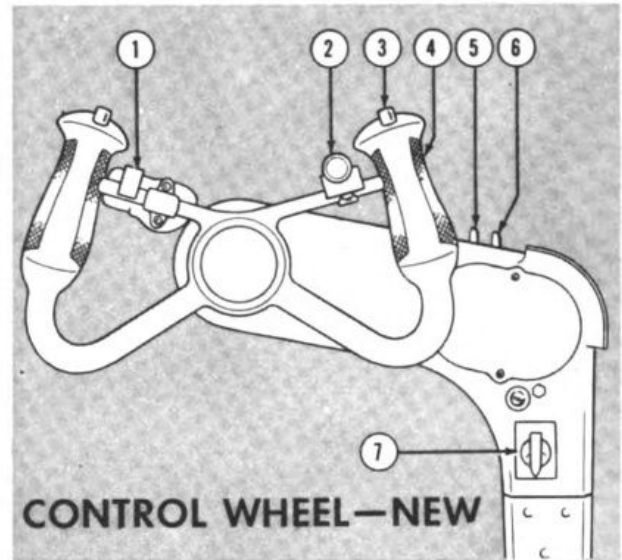

CONTROL WHEEL—NEW

1. Dive flap control.
2. Radio transmitter button.
3. Bomb-rocket release button.
4. Machine gun-cannon trigger button (back of wheel).
5. Bomb-rocket selector switch.
6. Gun-camera selector switch.
7. Gunsight light rheostat.

## SURFACE CONTROLS LOCK

Lock the flight controls by the tube assembly on the right-hand window sill.

To set the lock:

1. Put rudders in neutral.
2. Push the right end of the locking tube forward of the guiding angle.
3. Place the left end of the tube in the clip on the left window sill.
4. Strap the tube to the center of the control wheel.

On the P-38L and later P-38J's the surface controls lock does not lock the rudders.

## COCKPIT HEAT

Cockpit heat and warm air to defrost the windshield are supplied by an intensifier tube connected to the right engine exhaust. The cockpit heat control is on the right windshield support.

There is a heat outlet for your feet. Open and close it by the control on the floor under your right foot.

Later P-38 series have cockpit heat controls on both windshield supports and a heated flying suit plug and rheostat on the left side of the cockpit.

**BEFORE TAKEOFF, CHECK THE CONTROLS FOR FREEDOM OF MOVEMENT AND BE SURE THE CONTROLS LOCK IS STOWED IN PLACE**

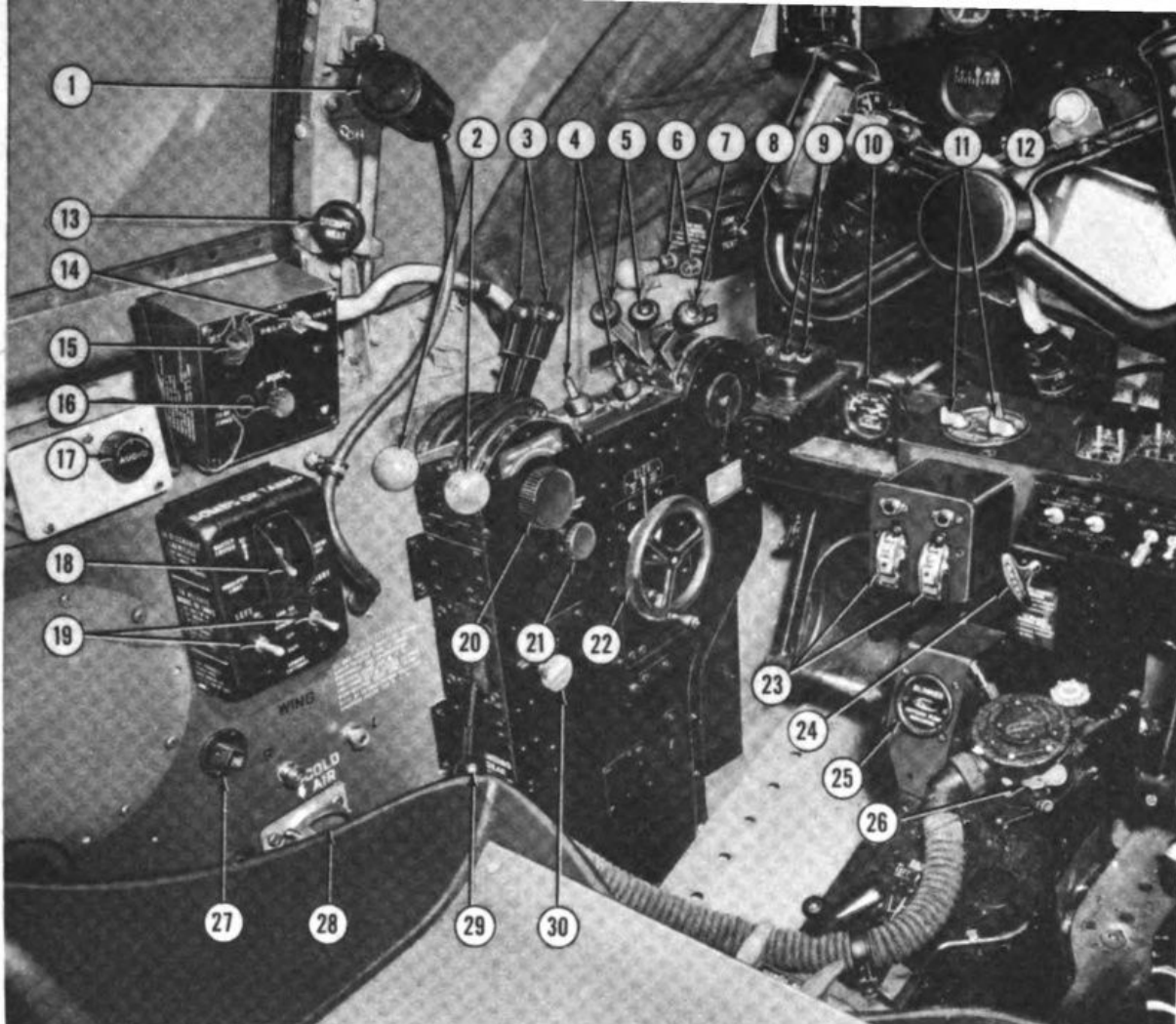

## COCKPIT—LEFT SIDE (P-38L-5)

- |  |  |
|--|--|
| 1. Spotlight (normal position).              | 17. Radio volume control.                        |
| 2. Throttles.                                | 18. Bomb-drop tank master switch.                |
| 3. Propeller governor controls.              | 19. Bomb-drop tank selector and arming switches. |
| 4. Propeller selector switches.              | 20. Friction control.                            |
| 5. Mixture controls.                         | 21. Propeller lever vernier knob.                |
| 6. Outer wing low level fuel warning lights. | 22. Elevator trim tab control.                   |
| 7. Air filter control.                       | 23. Propeller feathering switches.               |
| 8. Outer wing low level fuel test switch.    | 24. Parking brake handle.                        |
| 9. Propeller circuit breaker buttons.        | 25. Oxygen flow indicator.                       |
| 10. Oxygen pressure gage.                    | 26. Oxygen auto-mix lever.                       |
| 11. Ignition switches.                       | 27. Spotlight alternate position socket.         |
| 12. Radio transmitter button.                | 28. Cockpit ventilator control.                  |
| 13. Cockpit heat control.                    | 29. Landing gear control handle.                 |
| 14. Rocket arming switch.                    | 30. Landing gear control release knob.           |
| 15. Rocket selector switch.                  |  |
| 16. Rocket reset knob.                       |  |

**RESTRICTED**

**17**

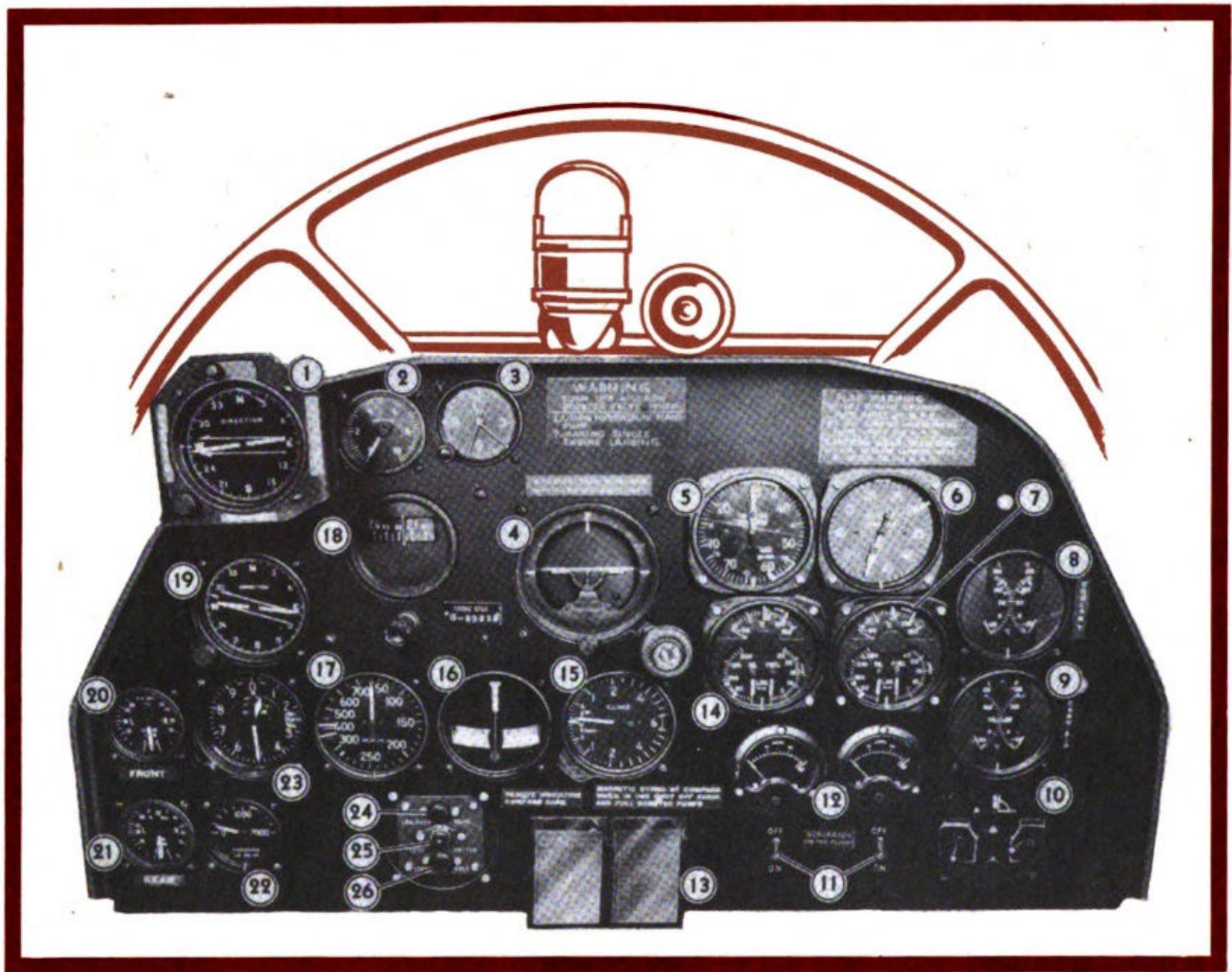

## INSTRUMENT PANEL (P-38J-25)

- |   |  |
|---|--|
| <ol style="list-style-type: none"> <li>1. Standby magnetic compass.</li> <li>2. Suction gage.</li> <li>3. Clock.</li> <li>4. Gyro horizon.</li> <li>5. Manifold pressure gages (left and right).</li> <li>6. Tachometers (left and right).</li> <li>7. Engine gage right engine (oil temperature and pressure and fuel pressure).</li> <li>8. Coolant temperature gage.</li> <li>9. Carburetor air temperature gage.</li> <li>10. BC-608 contractor (eliminated).</li> <li>11. Generator switches.</li> <li>12. Ammeters.</li> <li>13. Compass correction cards.</li> </ol> | <ol style="list-style-type: none"> <li>14. Engine gage left engine (oil temperature and pressure and fuel pressure).</li> <li>15. Rate of climb indicator.</li> <li>16. Bank and turn indicator.</li> <li>17. Airspeed indicator.</li> <li>18. Directional gyro.</li> <li>19. Remote indicating compass.</li> <li>20. Front (reserve) fuel tanks quantity gage.</li> <li>21. Rear (main) fuel tanks quantity gage.</li> <li>22. Hydraulic pressure gage.</li> <li>23. Altimeter.</li> <li>24. Landing gear warning light.</li> <li>25. Landing gear warning light test button.</li> <li>26. Spare bulb.</li> </ol> |
|---|--|

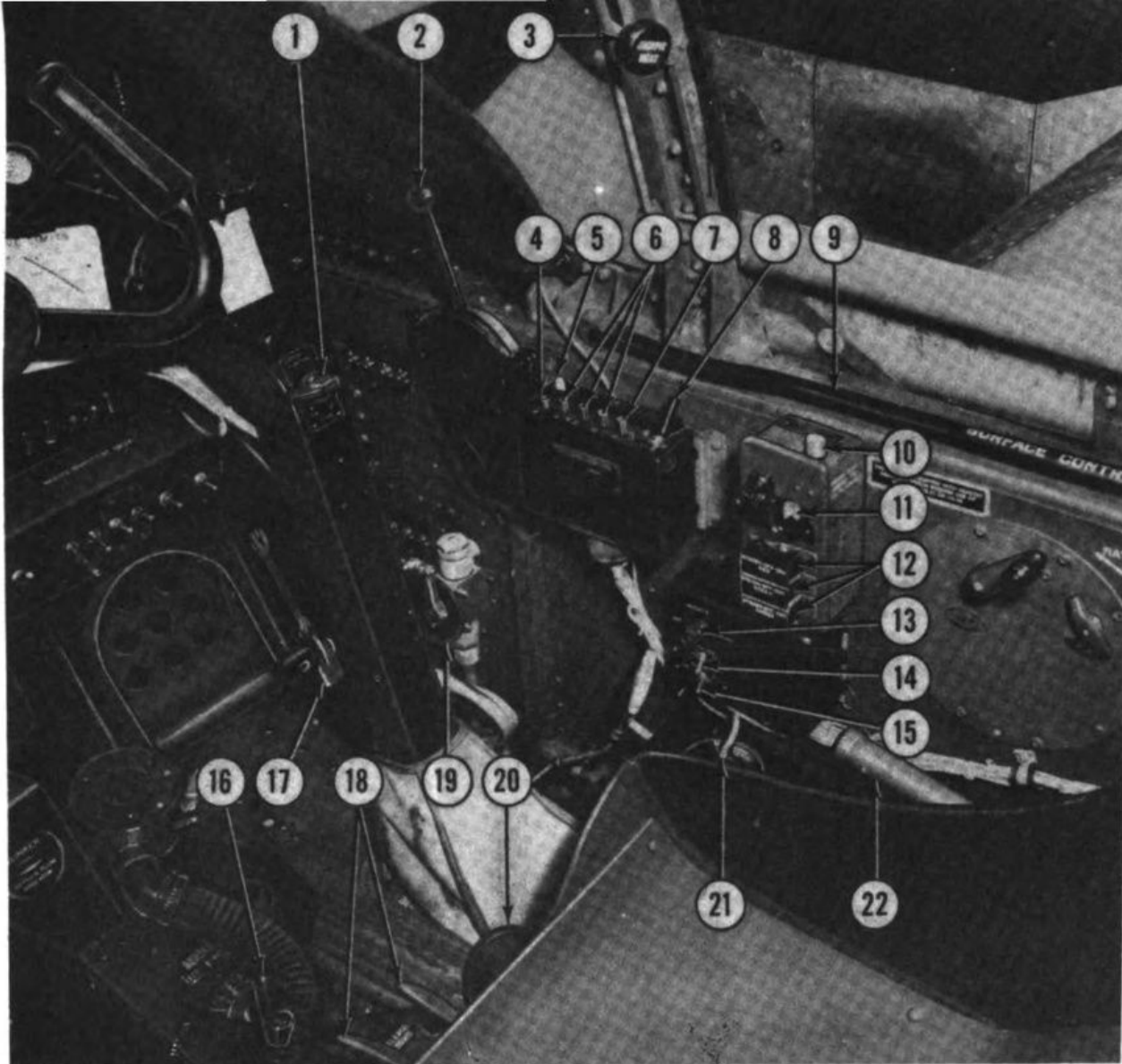

## COCKPIT—RIGHT SIDE (P-38L-5)

- |   |                                       |
|---|---------------------------------------|
| 1. Gunsight light rheostat.               | 12. Recognition light switches.       |
| 2. Flap control lever.                    | 13. AN/APS-13 warning light rheostat. |
| 3. Cockpit heat control.                  | 14. AN/APS-13 test switch.            |
| 4. VHF radio OFF push button.             | 15. AN/APS-13 ON-OFF switch.          |
| 5. Wing and tail position light switches. | 16. Rudder trim tab control.          |
| 6. Frequency selector push buttons.       | 17. Rudder pedal adjustment lever.    |
| 7. Selector lock lever.                   | 18. Manual bomb-drop tank release.    |
| 8. VHF radio control lever.               | 19. Aileron boost control lever.      |
| 9. Surface controls lock (stowed).        | 20. Relief tube.                      |
| 10. Recognition light keying button.      | 21. Low frequency range receiver.     |
| 11. Cockpit light.                        | 22. Hydraulic hand pump.              |

**RESTRICTED**

19

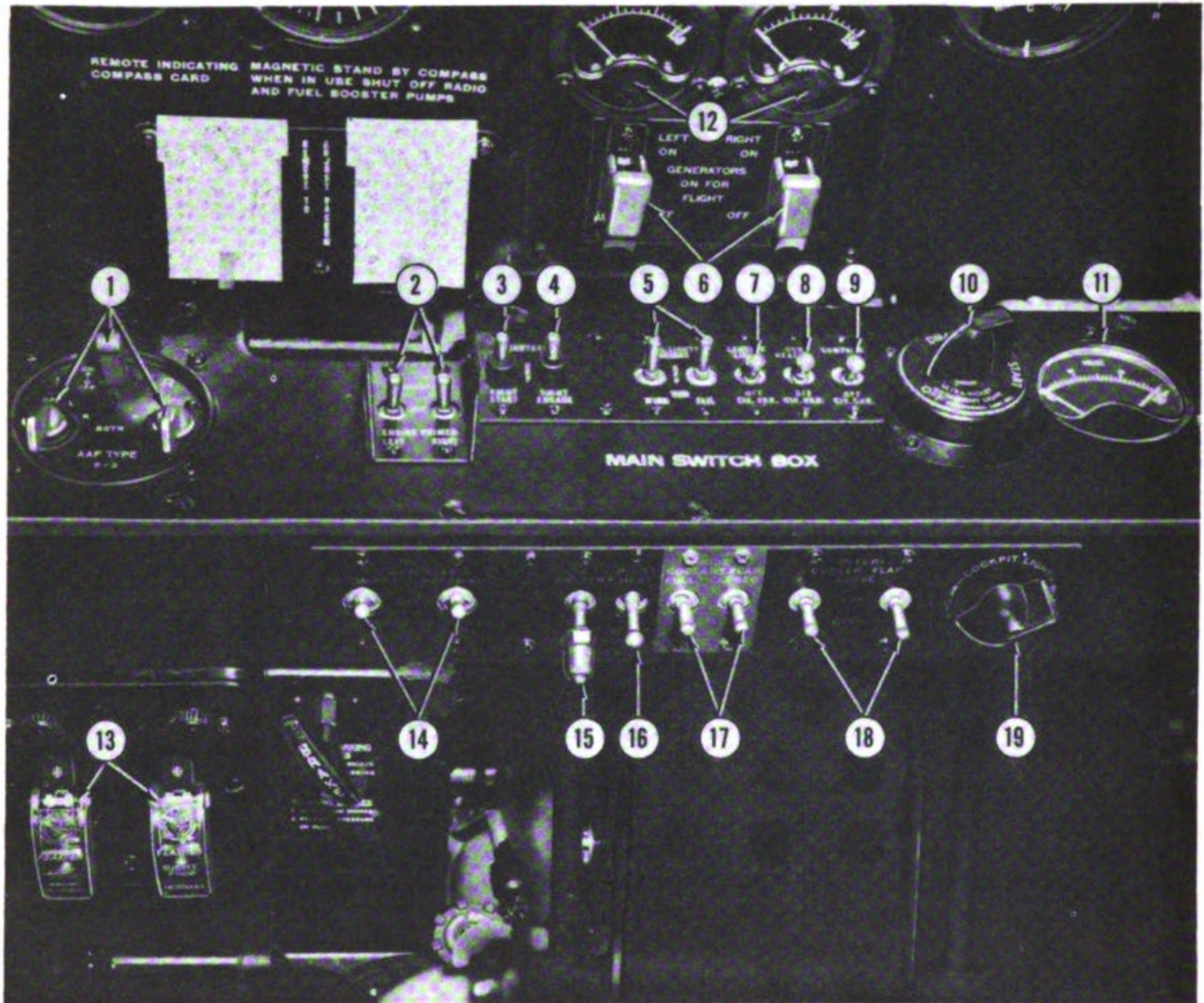

## MAIN SWITCH BOX (P-38L-5)

- |   |                                     |
|---|-------------------------------------|
| 1. Ignition switches.                       | 11. Voltmeter.                      |
| 2. Oil dilution and engine primer switches. | 12. Ammeter.                        |
| 3. Starter switch.                          | 13. Propeller feathering switches.  |
| 4. Engage switch.                           | 14. Oil cooler flap switches.       |
| 5. Wing and tail position light switches.   | 15. Battery switch.                 |
| 6. Generator switches.                      | 16. Pitot heat switch.              |
| 7. Landing light switch.                    | 17. Coolant flap override switches. |
| 8. Gun heater switch.                       | 18. Intercooler flap switches.      |
| 9. Compass light switch.                    | 19. Cockpit light rheostat.         |
| 10. Fluorescent light rheostat.             |                                     |

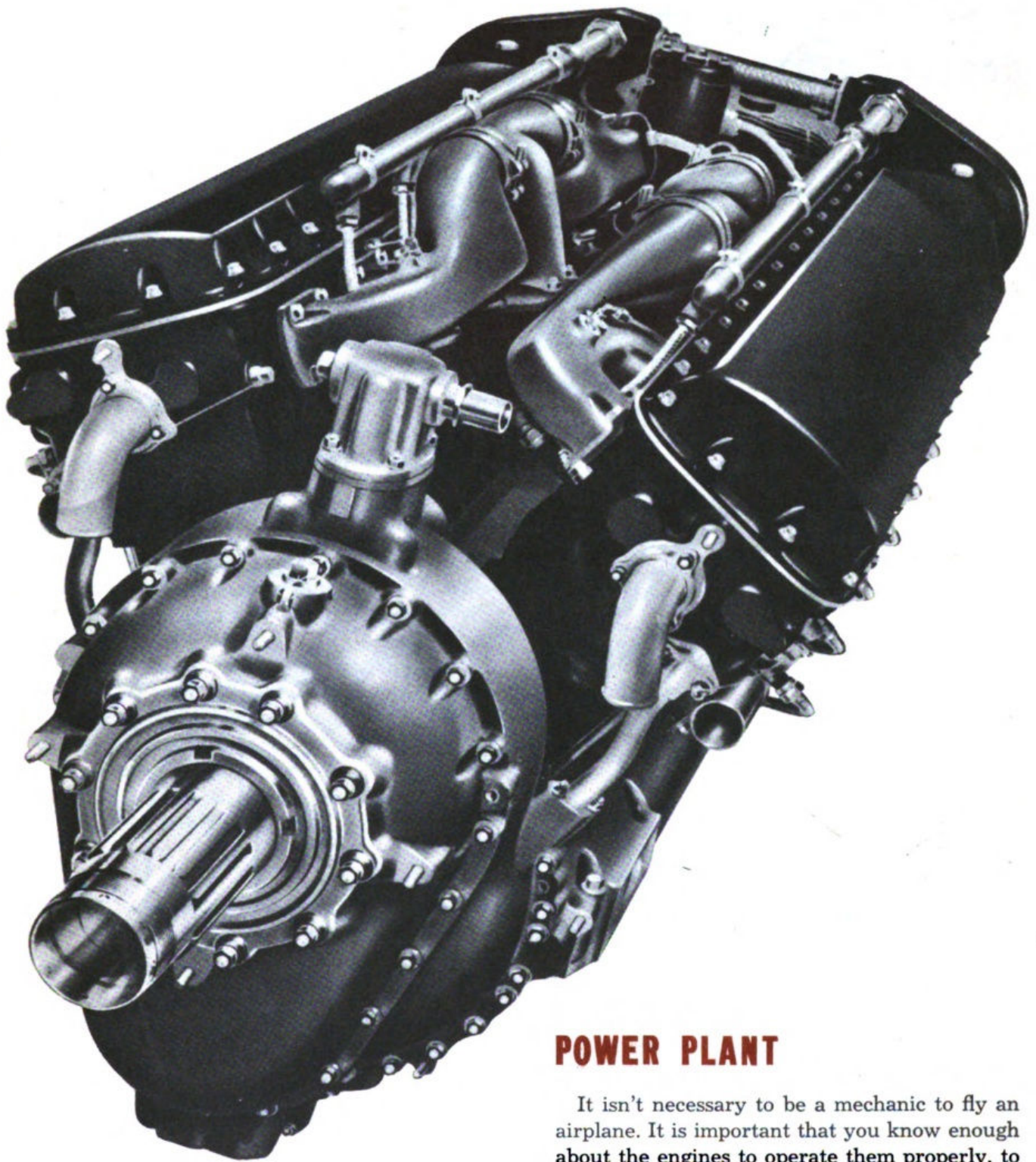

## POWER PLANT

It isn't necessary to be a mechanic to fly an airplane. It is important that you know enough about the engines to operate them properly, to know their limitations, and to recognize trouble.

The P-38 has two 12-cylinder V-1710 liquid-cooled Allison engines. Know them, understand them, and treat them with respect. These engines are your life insurance.

# COOLING SYSTEM

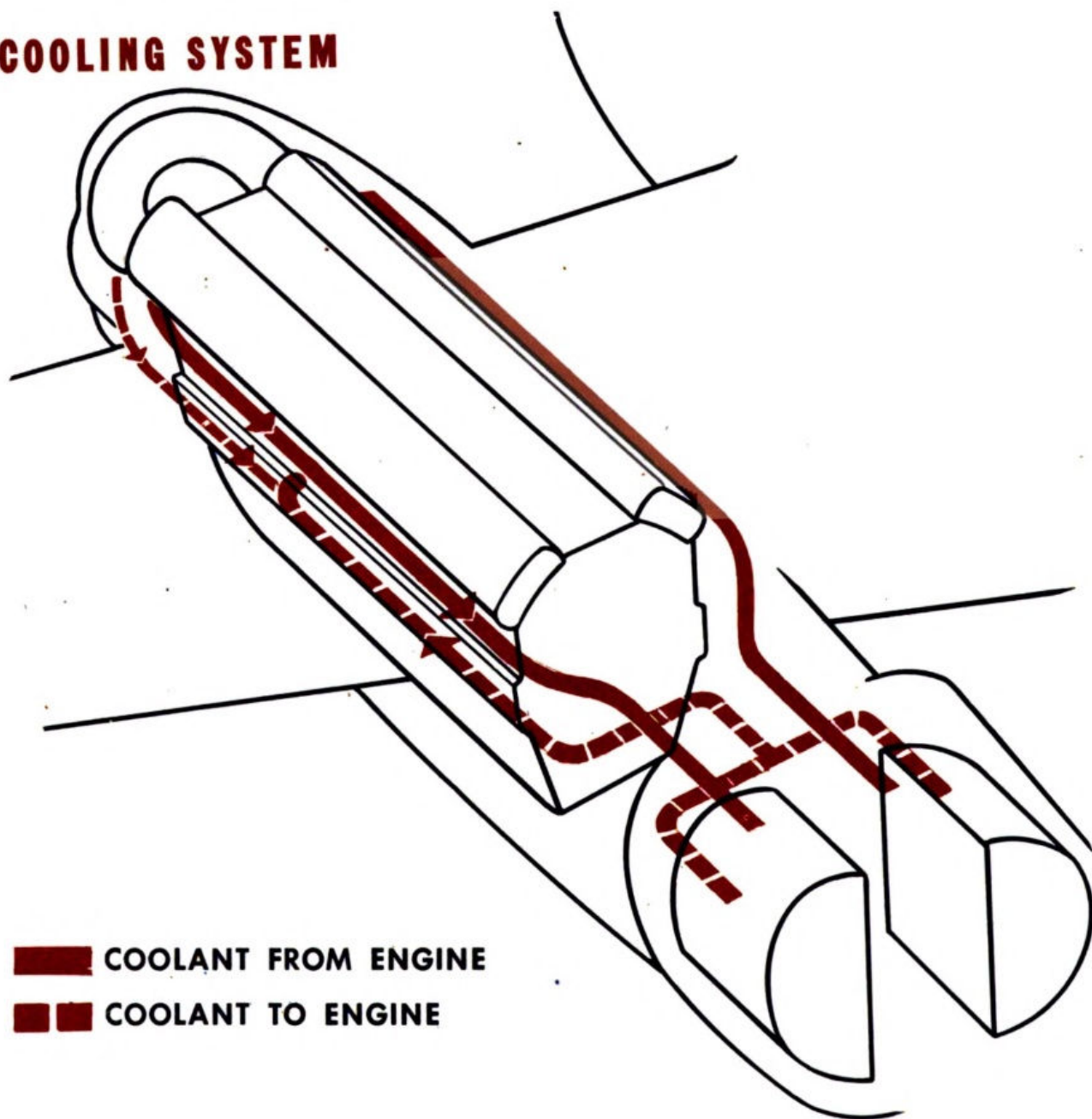

- COOLANT FROM ENGINE
- COOLANT TO ENGINE

The engines are liquid cooled with a separate cooling system for each. The coolant is ethylene glycol. The ethylene glycol has the same function as water in the radiator of an automobile.

The coolant absorbs excess heat and dissipates it through radiators on the tail booms. The cooling radiators have hydraulically operated flaps. Changing the position of the coolant flaps varies the flow of air through the radiators. This regulates the coolant temperature.

<i>Coolant Temperature</i>	
MINIMUM .....	85°C
DESIRED .....	100°C
MAXIMUM .....	110°C

**P-38 Series Through P-38G-10**

Operate the coolant flaps by levers located on the engine control stand at the base of the left window.

The coolant flap control levers have 3 positions: Push them forward to open the flaps, and rearward to close them. The center position is neutral. You can stop the flaps in any desired position by returning the levers to neutral.

Look over your shoulder to check the position of the flaps.

If the hydraulic system fails, you can operate the coolant flaps by the auxiliary hand pump, but not by the emergency extension system.

**P-38G-15 Through P-38L-5**

Two coolant override switches on the main switch box replace the coolant flap control levers.

The switches have 3 positions: OFF, FULL OPEN, and FULL CLOSED.

Place the switches in the OFF position and the coolant flaps operate automatically, maintaining the coolant temperature between 94°C and 114°C.

Operate the coolant flaps manually in the FULL OPEN or FULL CLOSED position. Use these positions if the automatic OFF position fails to maintain the desired temperature. You cannot set the coolant flaps to any position other than full open or full closed when using the coolant override switches.

The coolant override system works only if hydraulic pressure is available and the electrical system is operating.

If the hydraulic system fails completely, the coolant flaps assume a streamlined position.

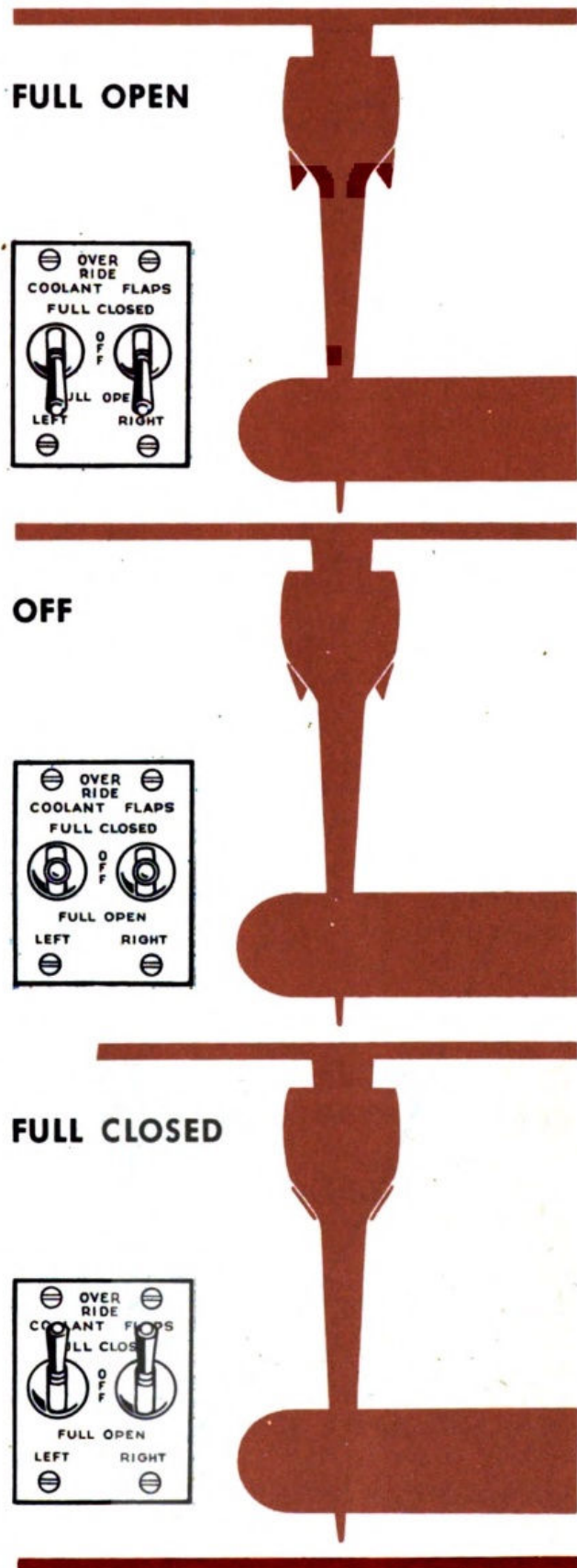



# OIL SYSTEM

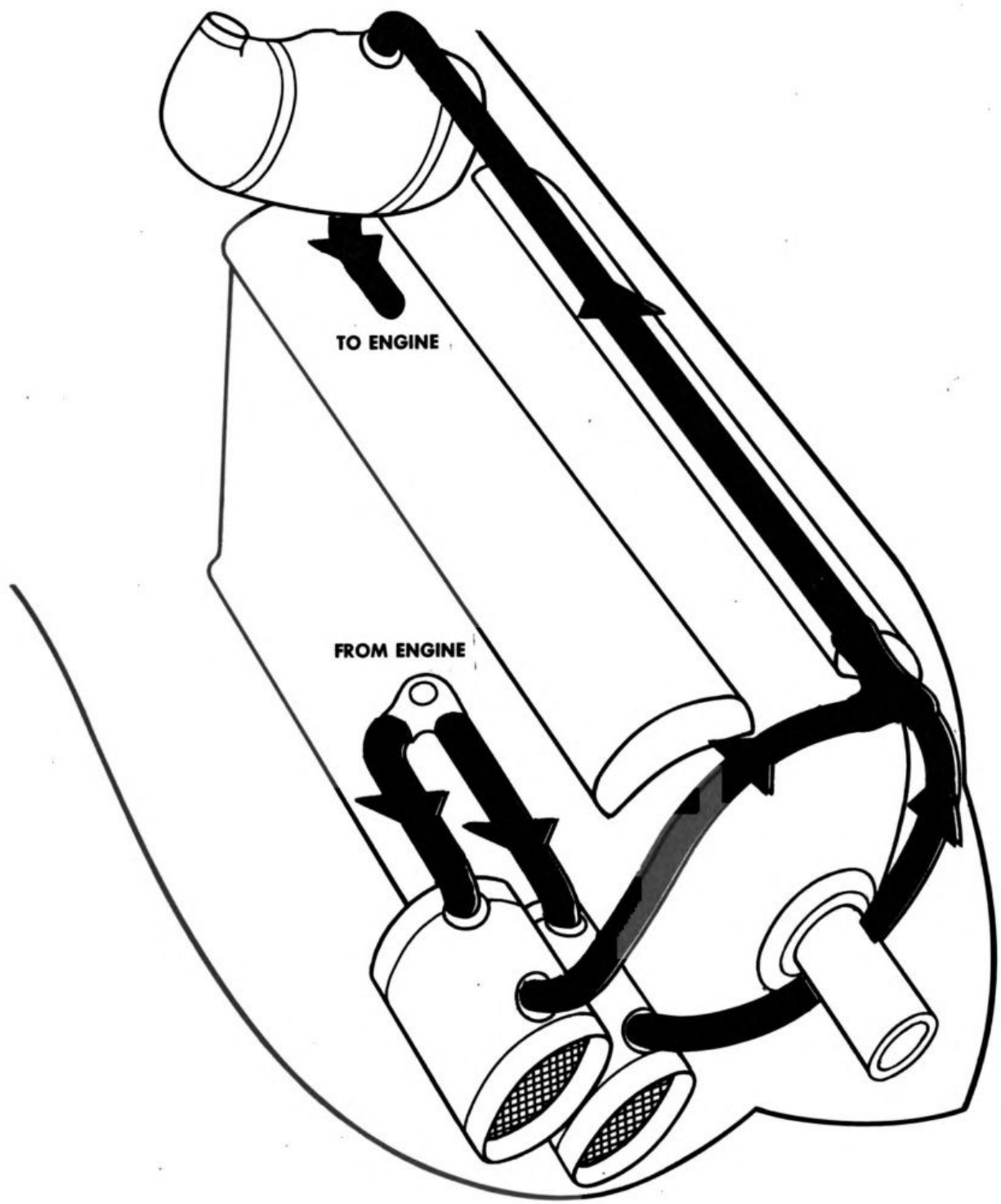

**Oil Cooler Shutters**

Oil is cooled by air passing through oil radiators in front of the nacelles. Oil cooler shutters on the bottom of the nacelles vary the flow of air through the radiators.

You can see the oil shutters by leaning forward in the cockpit and looking at the bottom of the engine cowl.

**Note:** When flying in cold weather or at altitude with extremely low outside air temperature, the oil in the cooler may congeal. This condition exists if the oil temperature continues to rise with the oil cooler shutters open. Close the shutters and the oil temperature will decrease.

*Oil Temperature*

MINIMUM ..... 40°C

DESIRED ..... 60°C to 90°C

MAXIMUM ..... 100°C

**P-38H Through P-38L-5**

The oil shutter switches have 4 positions: AUTOMATIC, OFF, OPEN, and CLOSE. Place the switches in the AUTOMATIC position, and the oil temperature is automatically regulated between 75°C and 95°C. To operate the shutters manually, place the switches in the OPEN or CLOSE position, and when the shutters have reached the desired position, return the switches to OFF. Both automatic and manual operation of the oil cooler shutters is entirely electrical.

The oil shutters are on the sides of the nacelles instead of the bottom. You can see them from the cockpit. For that reason this series does not have oil shutter position indicators.

**Oil Pressure**

You must maintain proper oil pressure to operate the engines efficiently. Here are a few general rules that will help you:

Always check the pressure and temperature relationship.

With low pressure and high temperature—open the oil shutters; the temperature will go down and the pressure up.

With high pressure and low temperature—close the oil shutters; the temperature will go up and the pressure down.

If the pressure is either high or low and the oil temperature is normal, reduce power and land.

You can bring the plane home under reduced power if the oil pressure does not go below 40 psi.

If the oil pressure is below 40 psi close the throttle, cut the mixture control and feather the propeller of the engine. Single engine flight is no problem, whereas if you continue to use the bad engine it can develop into a serious fire hazard.

**Oil Dilution**

The oil dilution system allows gasoline to flow into the oil system. Diluting the oil in cold weather makes it easier to start the engines.

**Important:** Oil dilution is not effective if the oil temperature is above 40°C and coolant temperature above 70°C. Stop the engines and allow them to cool before proceeding.

**To dilute the oil:**

1. Run engines at 1000 rpm.
2. Move oil dilution switches to ON position and hold for required time. The oil and fuel pressures will drop.

Oil Dilution in Minutes	
Anticipated Outside Air Temperature	Dilution Time
4°C to —12°C.....	3 min.
—12°C to —29°C.....	5 min.
—29°C to —46°C.....	8 min.

3. Move mixture control to IDLE CUT-OFF.
4. When engines stop, release oil dilution switches.

**Note:** If oil has been diluted the night before, check to see that oil pressure is up and constant before takeoff.

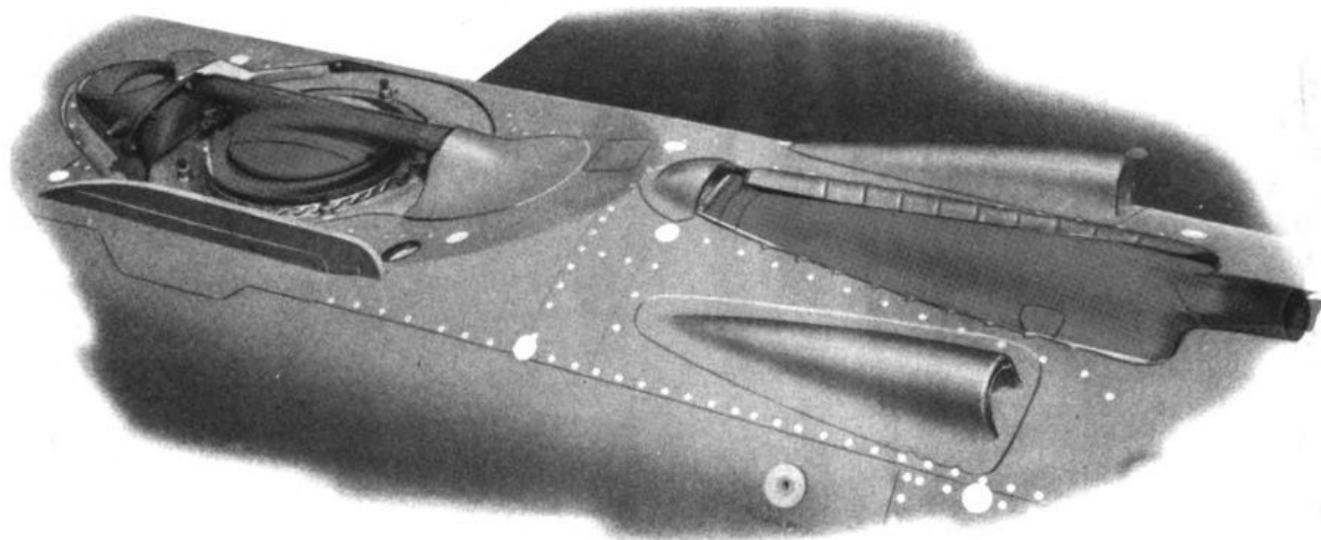

## SUPERCHARGERS AND THROTTLE

The P-38 is equipped with two exhaust-driven turbo-superchargers. They are on the top surfaces of the tail booms aft of the engine nacelles. A supercharger is to an engine as an oxygen mask is to you at high altitudes. Superchargers increase the density of air in the cylinders to provide maximum performance of the engines at high altitudes.

There are no additional controls to operate the superchargers. They are mechanically connected to the throttles and operate automatically when you advance the throttles.

In the two-thirds to wide open range of the throttles, engine response is sluggish. This lag is the time required for the superchargers to reach their new speed.

**Note:** Operate the throttles the same way you operate conventional throttles. Later P-38 series have throttle hooks installed on the left throttle. These hooks mechanically advance the propeller governor levers when the throttles are advanced, thereby preventing high manifold pressures with insufficient rpm. They do not move the propeller governors in correct relation to throttle advancement. Their purpose is to pull the governors forward if, having to add power rapidly, you forget to advance propeller governors first. By depressing the throt-

tle hook lever, the hook by-passes the governors.

As you advance the throttles beyond two-thirds of the quadrant, a valve on the exhaust is gradually closed. This valve is similar in operation to the butterfly valve on the carburetor. It is called the waste gate. The more the waste gate closes, the faster the turbo wheel spins; the faster the turbo wheel spins, the greater the compression of air to the cylinders. The turbo speed increases with an increase of altitude and throttle. The critical altitude at which the superchargers will maintain sea level ratings for the engines is determined by the rpm limitation of the turbos. If you exceed this rpm limitation by using more than the prescribed manifold pressure, the turbos overspeed and serious material damage can result.

Decrease the allowable manifold pressure one inch per thousand feet above 25,000 feet on P-38F and P-38G series. Start to decrease manifold pressure above 30,000 feet on P-38H through P-38J-15 series. This keeps the turbos within their rpm limitations.

**Note:** The allowable manifold pressure varies in each P-38 series at different altitudes. Refer to T. O. 01-75-1 for the allowable manifold pressure of the P-38 series you are going to fly.

### Turbo Overspeed Warning Lights

Turbo overspeed warning lights are installed on the instrument panel of the P-38H and P-38J.

The warning lights flicker when the turbos are reaching their rpm limitation. They burn steadily when the rpm limitation is reached. Their intensity increases as this limitation is exceeded.

While the lights flicker you have a safety margin and can reduce the turbo speed before serious damage results. Reduce the engine power before the lights burn steadily.

### Manifold Pressure Regulator

P-38L's and later series of the P-38J have a manifold pressure regulator which automatically controls the carburetor butterfly valve. It provides a constant manifold pressure for any given throttle setting during climb, descent and maneuvers. It also prevents the manifold pressure from exceeding its limits in a dive.

### Turbo Supercharger Regulator

P-38L's and later P-38J's have a turbo regulator incorporating an overspeed governor that prevents the turbo wheel from running at speeds beyond the safety limit. These models do not have turbo overspeed warning lights. The regulator is automatic. You don't have any control over its operation.

### Intercoolers

The temperature of air passing through the turbo-superchargers increases because of compression.

The intercoolers cool the hot air from the supercharger before it enters the carburetors. Previous to the P-38J, the intercoolers were in the leading edge of the wing and the pilot did not control them.

The intercoolers on later airplanes are in the nacelles. The space inside the leading edge of the wing, outboard of the nacelles, is used for outer wing fuel tanks and a left leading edge landing light. In the nacelles, the intercoolers have greater protection from enemy gunfire, are accessible to mechanics for maintenance and you control their operation.

RESTRICTED

The P-38J and P-38L series are provided with intercooler shutters on the bottom of the engine nacelles. By opening or closing the shutters, you can control the carburetor air temperature.

Operate the intercooler shutters by two toggle switches on the main switch box. The switches have 3 positions: OPEN, OFF, and CLOSE. You can stop the shutters in any desired intermediate position by returning the switches to OFF. They operate in the same manner as the oil shutters on all P-38 series previous to the J.

### Carburetor Heat

The turbo-superchargers automatically provide carburetor heat. It is possible, however, to encounter carburetor icing during icing conditions and extreme cold when operating at low power.

If carburetor icing occurs, increase power into turbo-supercharger range. This increases the temperature of the carburetor air and clears away the ice.

Keep the carburetor air temperature between 20°C and 35°C.

Maximum carburetor air temperature is 45°C.

**Note:** With extremely high outside air temperature, carburetor air temperature exceeds 45°C during ground operation.

Carburetor temperature on P-38J and P-38L is controlled by adjustment of the intercooler shutters.

### Carburetor Air Filters

Use carburetor air filters during dusty ground operation. On earlier P-38 series the air filters operate automatically. They remain open on the ground and close when the wheels are retracted.

When operated manually, do not use them once you are off the ground and in clear air. The use of carburetor air filters **reduces the critical altitude and range of the airplane.**

The carburetor air filter manual control is to the left, behind the pilot's seat. On P-38J's and P-38L's the control is on the engine control stand in place of the coolant shutter controls.

# MIXTURE CONTROLS

The engines have pressure type carburetors that maintain an automatic fuel mixture at any altitude. The mixture controls have 4 main settings: **EMERGENCY RICH**, **AUTO RICH**, **AUTO LEAN**, and **IDLE CUT-OFF**.

Use these positions as follows:

## Idle Cut-off

For starting and stopping the engines. The controls are left in this position when the engines are not running.

## Auto Lean

For economical cruising at any altitude.

## Auto Rich

For takeoff, climbing, cruising at any altitude, and landing.

## Emergency Rich

For emergency use, when the automatic feature of the carburetor fails.

Although the **AUTO RICH** and **EMERGENCY RICH** settings of the clover leaf valve are similar, the **EMERGENCY RICH** setting differs in that it bypasses the automatic feature of the carburetor.

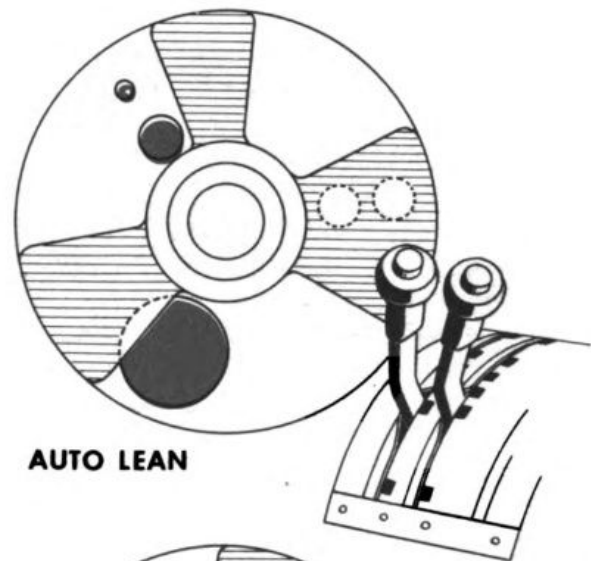

**AUTO LEAN**

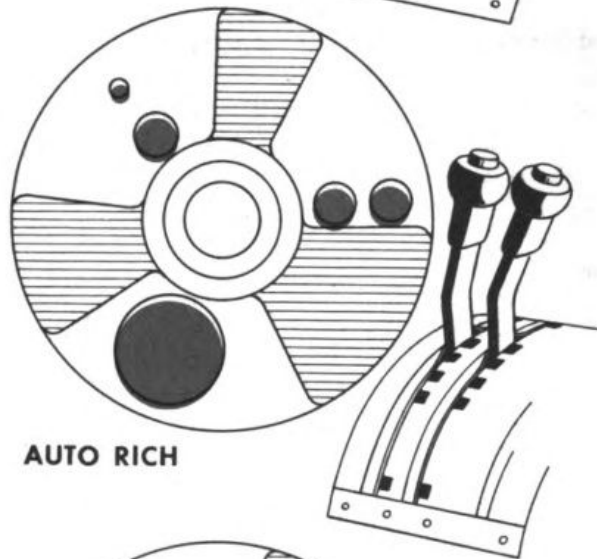

**AUTO RICH**

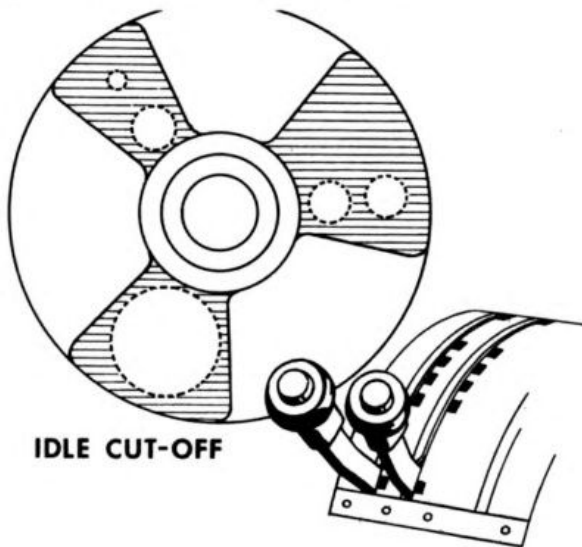

**IDLE CUT-OFF**

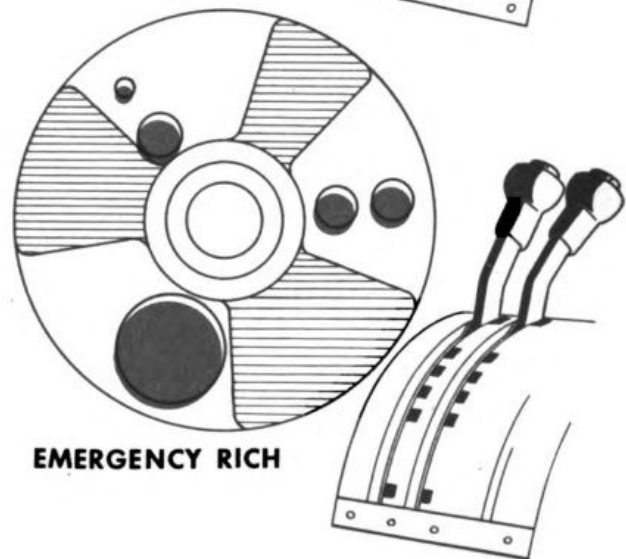

**EMERGENCY RICH**

# CURTISS ELECTRIC PROPELLER

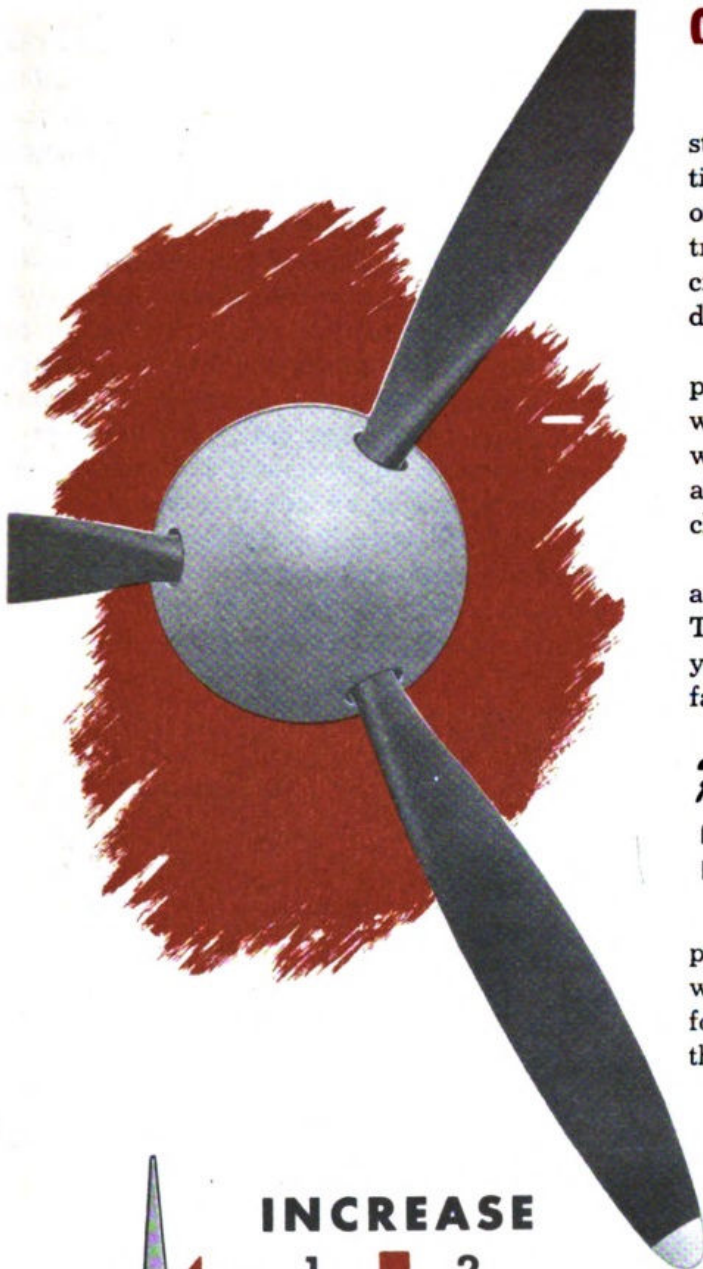

You have been using the hydromatic constant speed propeller; now you have two Curtiss electric propellers. You know the principle of operation. The angle of the blades is controlled while in flight to provide maximum efficiency and maintain constant engine speed under varying operating conditions.

The propellers are counter-rotating. The propeller on the right engine rotates clockwise while the one on the left rotates counter-clockwise. This eliminates torque and provides the airplane with excellent climbing and diving characteristics. That means less work for you.

There is a control which gives you either automatic constant speed or manual fixed pitch. There is also an emergency control enabling you to feather either propeller in case of engine failure.

## Remember

**Increase rpm first, then manifold pressure.  
Decrease manifold pressure first, then rpm.**

Later P-38 series have throttle hooks. Their purpose is to pull the propeller governors forward, if, having to add power rapidly, you forget to advance the governors before the throttles.

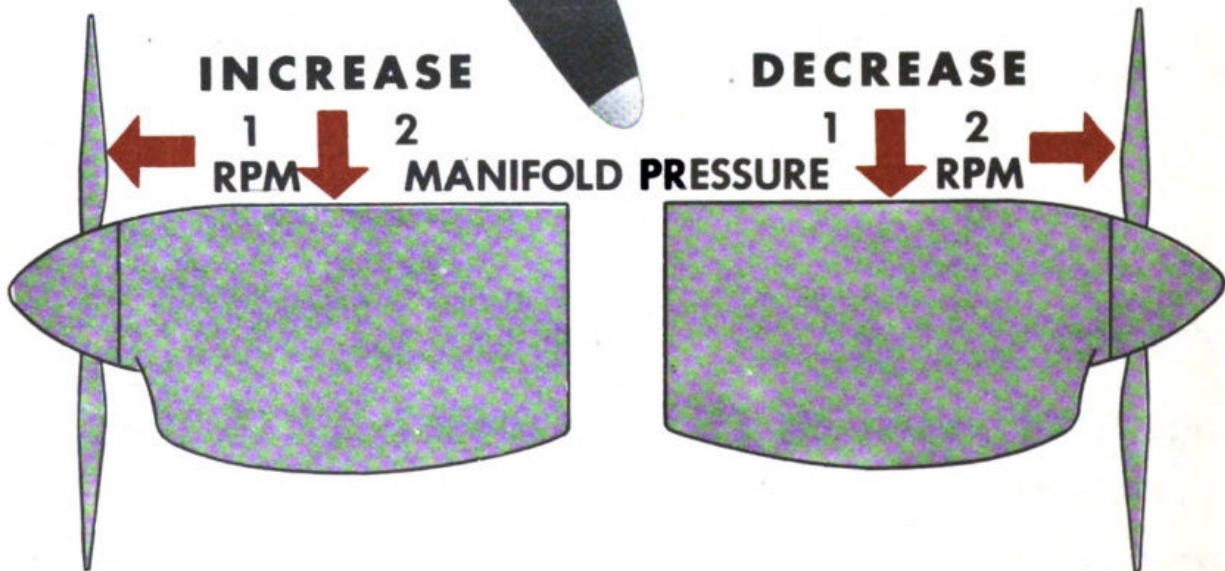

**Propeller Circuit Breaker**

Curtiss electric propellers have circuit breakers which protect them against electrical overloads. Keep circuit breakers set at all times.

The P-38 has push button type circuit breakers forward of the engine control stand. They operate like a pop-out cigarette lighter in an automobile. When an overload occurs in the propeller circuit, these buttons become hot and pop out, disclosing a red and white band. To reset the circuit breakers, first place the propeller selector switches in the manual **FIXED PITCH** position, allow the circuit breakers to cool for 10 to 15 seconds, then push the circuit breaker buttons in firmly. Return the propeller selector switches to **AUTOMATIC**.

If the circuit breaker buttons pop out again

with the propeller switches in **AUTOMATIC**, it is an indication of a permanent overload in the **AUTOMATIC** circuit. Return the propeller switches to manual **FIXED PITCH**, reset the circuit breakers, and fly the airplane with fixed pitch propellers.

A short in the system will cause the circuit breaker buttons to pop out continually, in spite of repeated attempts to reset them. Under such circumstances you have no alternative but to leave the circuit breakers out. You can still change the propeller pitch manually as outlined on the next page, under **Manual Operation**, but to do so, you must hold the circuit breaker buttons in at the same time. You can also reduce the rpm if necessary by moderate use of the feathering switch.

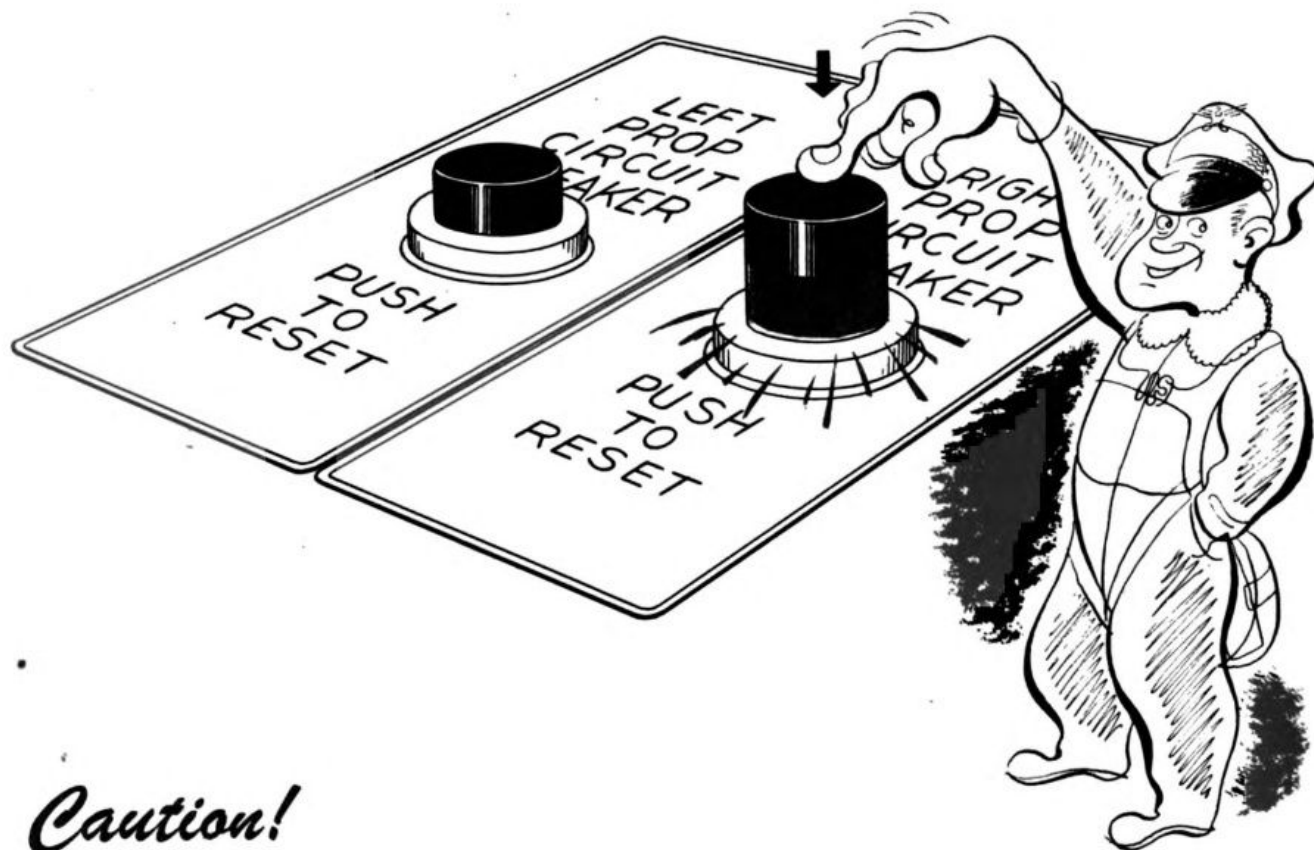

*Caution!*

**CHECK BEFORE TAKEOFF AND FREQUENTLY DURING FLIGHT THAT THE CIRCUIT BREAKERS ARE SET.**

### Automatic Constant Speed

In AUTOMATIC, a governor and a relay maintain a constant engine speed within the limits of the control lever operation. The control levers are on the engine control stand. They operate the propellers in the same way they operate the propellers on the AT-6 and AT-9. Pull them back and you decrease the rpm. Push them forward and you increase the rpm. For takeoff **the control levers are full forward**. Change them to provide the correct rpm for climb, cruise, and other maneuvers.

A vernier knob is on the side of the engine control stand. You can obtain fine adjustment of the right hand propeller governor with the vernier.

Synchronize propellers by ear, using the tachometers, and the vernier. Use the friction control to prevent the throttles and propeller

governors from vibrating out of position. Remember the rule:

**"Increase rpm before increasing manifold pressure. Decrease manifold pressure before decreasing rpm."**

### Manual Fixed Pitch

In manual FIXED PITCH the propellers operate as fixed pitch propellers. This position is used to conserve the battery if the generators fail, or if the automatic constant speed control fails to operate.

### Manual Operation

1. Move selector switch to FIXED PITCH.
2. Hold selector switch momentarily to INCREASE RPM or DECREASE RPM (as required).
3. When you obtain desired rpm setting, return selector switch to FIXED PITCH.

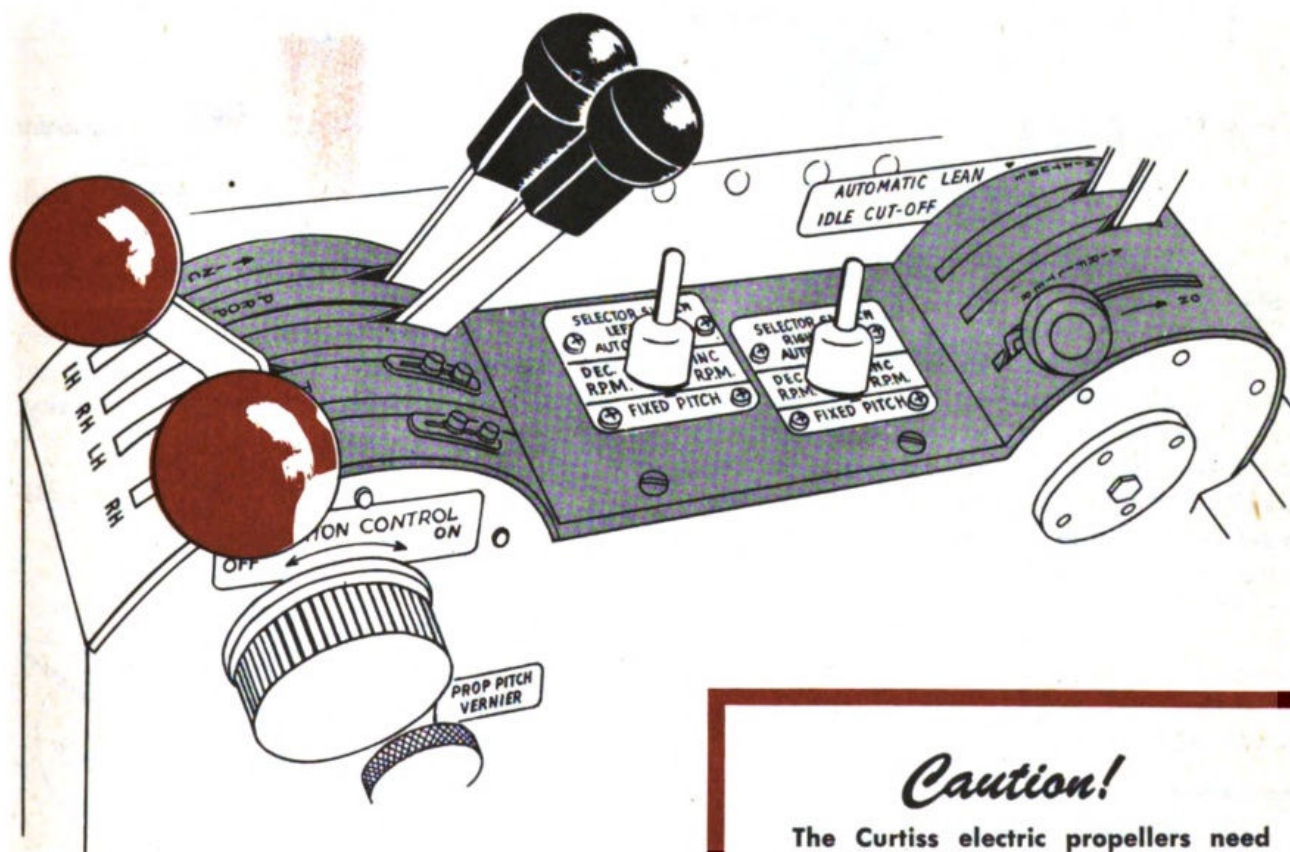

## Caution!

The Curtiss electric propellers need electricity to operate. Turn the generators ON, and make sure they are working.



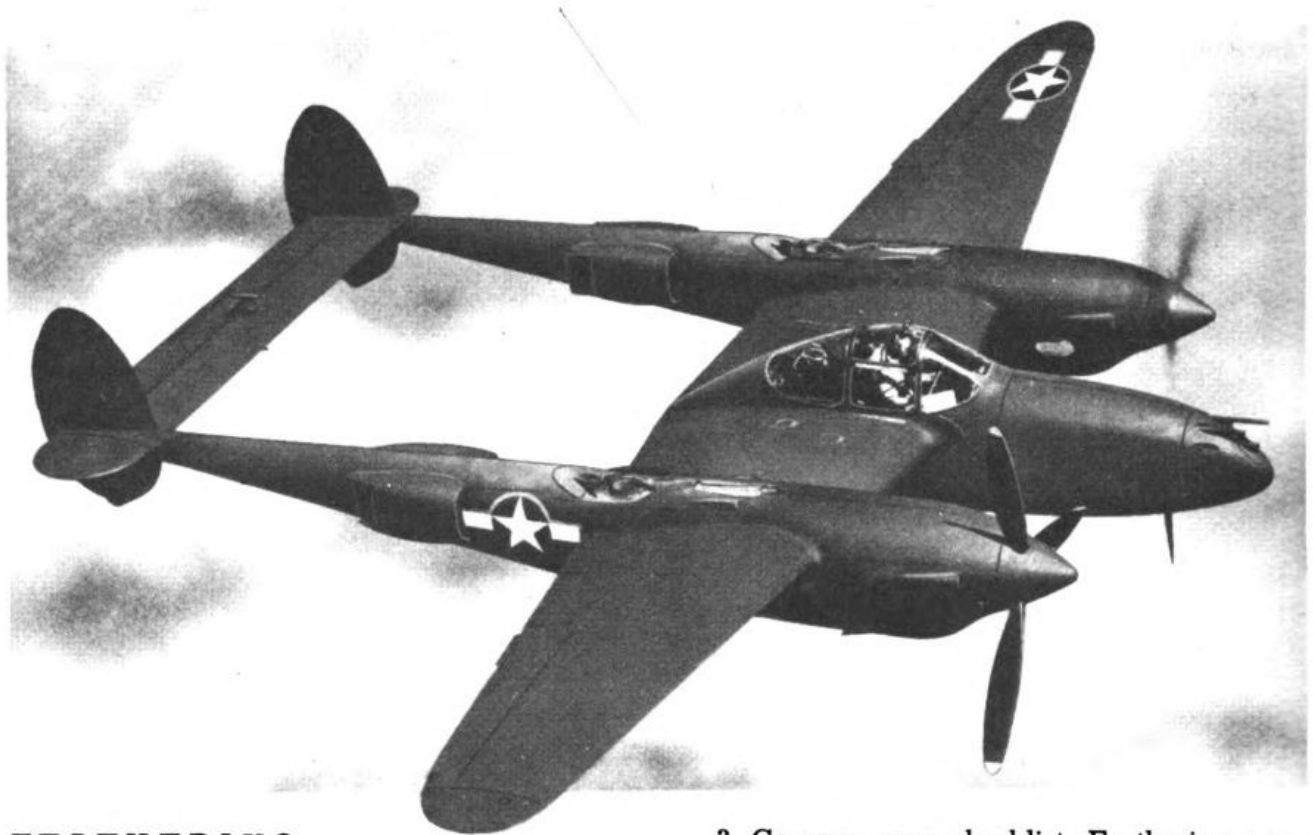

## FEATHERING

Feathering a propeller permits you to stop a disabled and vibrating engine. It decreases the drag of the propeller and increases the single engine performance of the airplane.

The feathering control switches have two positions: **NORMAL** and **FEATHER**. To feather a propeller, **all you have to do** is place the feathering control switch at **FEATHER**. The feathering switch by-passes the **AUTOMATIC** and manual **FIXED PITCH** switches. Regardless of the position of the selector switches, the propeller blades turn to the feather angle and stop.

If you can't feather a propeller with the feathering switch, you can feather by holding the propeller selector switch in the manual **DECREASE** position.

### Featheritis

If you develop engine trouble in flight, don't jump for the feathering switch.

1. Don't get in a hurry to land.
2. You have a good single engine airplane under you.

3. Go over your checklist. Feathering may not be necessary.

4. Definitely determine which engine is bad. Wrong engines have been feathered.

5. Check the airplane thoroughly. Try to determine the cause.

**Note:** You may be out of gas. Switch to fullest tank. Remember, don't be in a hurry, don't get excited. You're not going to fall out of the sky.



### Feathering Indicator Lights

On later P-38's, feathering indicator lights located above the feathering switches help you feather the propeller of a bad engine. If your right engine fails, you push hard left rudder to correct yaw. The right feathering light then glows, indicating that the right propeller is the one to be feathered. The reverse is true if the left engine fails.

### Unfeathering

1. Return feather switch to NORMAL.
2. Hold propeller selector switch to INCREASE RPM until tachometer reading is approximately 1000 rpm.
3. Move propeller selector switch to AUTOMATIC. This brings the rpm up to the setting of the propeller governor lever.

### Overspeeding Propeller

An overspeeding propeller is one which allows the engine to overspeed. If you have an overspeeding prop, immediately retard the throttle to 3000 rpm. Then do the following:

1. Check to be sure propeller selector switches are in AUTOMATIC.
2. Make certain circuit breakers are in.
3. Try to reduce rpm by propeller governor.
4. Hold selector switch in DECREASE RPM position.

If this fails to reduce the rpm, place feather switch to FEATHER and return it to NORMAL when desired rpm is reached. Be careful not to reduce the rpm too much when using this method.

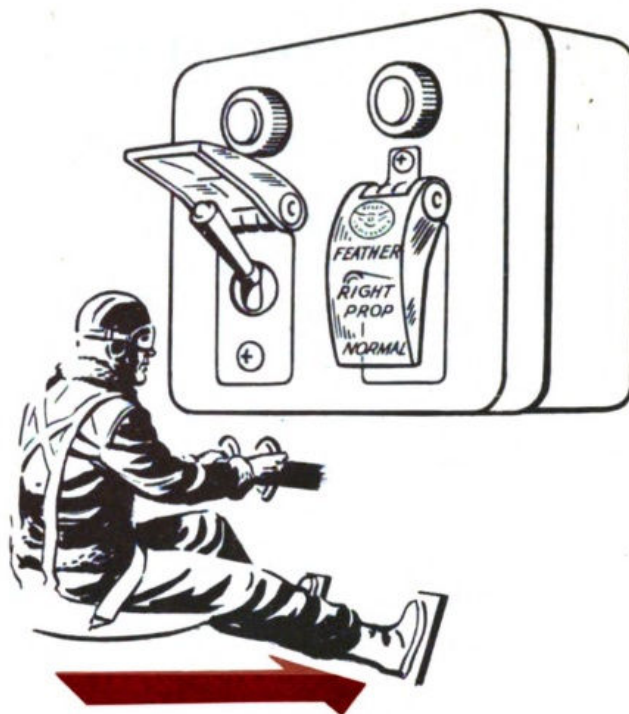

### Warning Lights

Propeller warning lights are installed on the P-38H only. They indicate when the propeller circuits are not properly set for takeoff and landing. They blink on and off when the circuit breakers are open, or when the propeller selector switches are not set in AUTOMATIC. However, these lights do not warn of an improperly set propeller pitch control.

# PROPELLER PREFLIGHT CHECK

Check to see that propeller circuit breaker buttons are in.

## Automatic Operation Check

1. Propeller selector switches in **AUTO-MATIC**.
2. Propeller governors in the full forward takeoff position.
3. Open throttles to obtain 2300 rpm.
4. Pull the propeller governors back until you get a reduction of 200 rpm.
5. Return the propeller governors to the full forward takeoff position, noting that they return to 2300 rpm. If they do, the propellers are operating normally and are ready for flight.

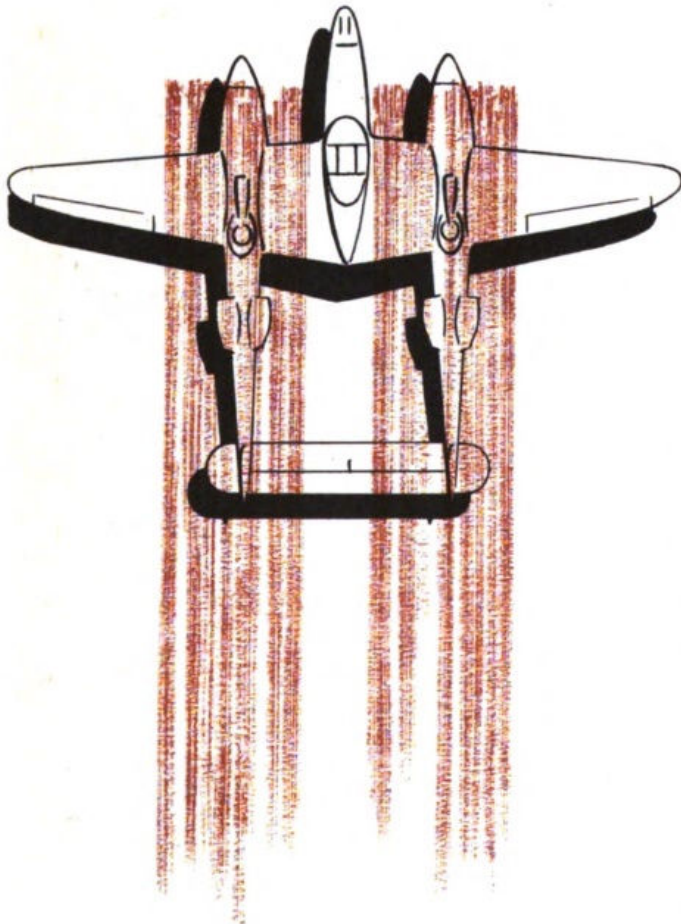

## *Remember!*

**Increase rpm first, then manifold pressure.  
Decrease manifold pressure then rpm.**

# PROPELLER CHECKLIST

## Generator Switch

Be sure it is **ON** and working properly. The Curtiss electric propeller needs electricity to operate.

## Circuit Breakers

Buttons in at all times.

## Feather Switch

In **NORMAL** position.

## Takeoff

Propeller selector switches in **AUTOMATIC**. Propeller control governors full forward in takeoff position.

## Cruising

Selector switches in **AUTOMATIC**. Obtain desired rpm with propeller governors.

## Landing

Selector switches in **AUTOMATIC**. Set to 2600 rpm with governors.

## After Landing

Before stopping the engines, move the governors full forward to takeoff position.

# FUEL SYSTEM

## Note:

All P-38L-5 airplanes and some P-38L-1 and P-38J airplanes have a modified fuel system. All P-38 series with the old system will be referred to as unmodified airplanes and the P-38 series that have the new system will be referred to as modified airplanes.

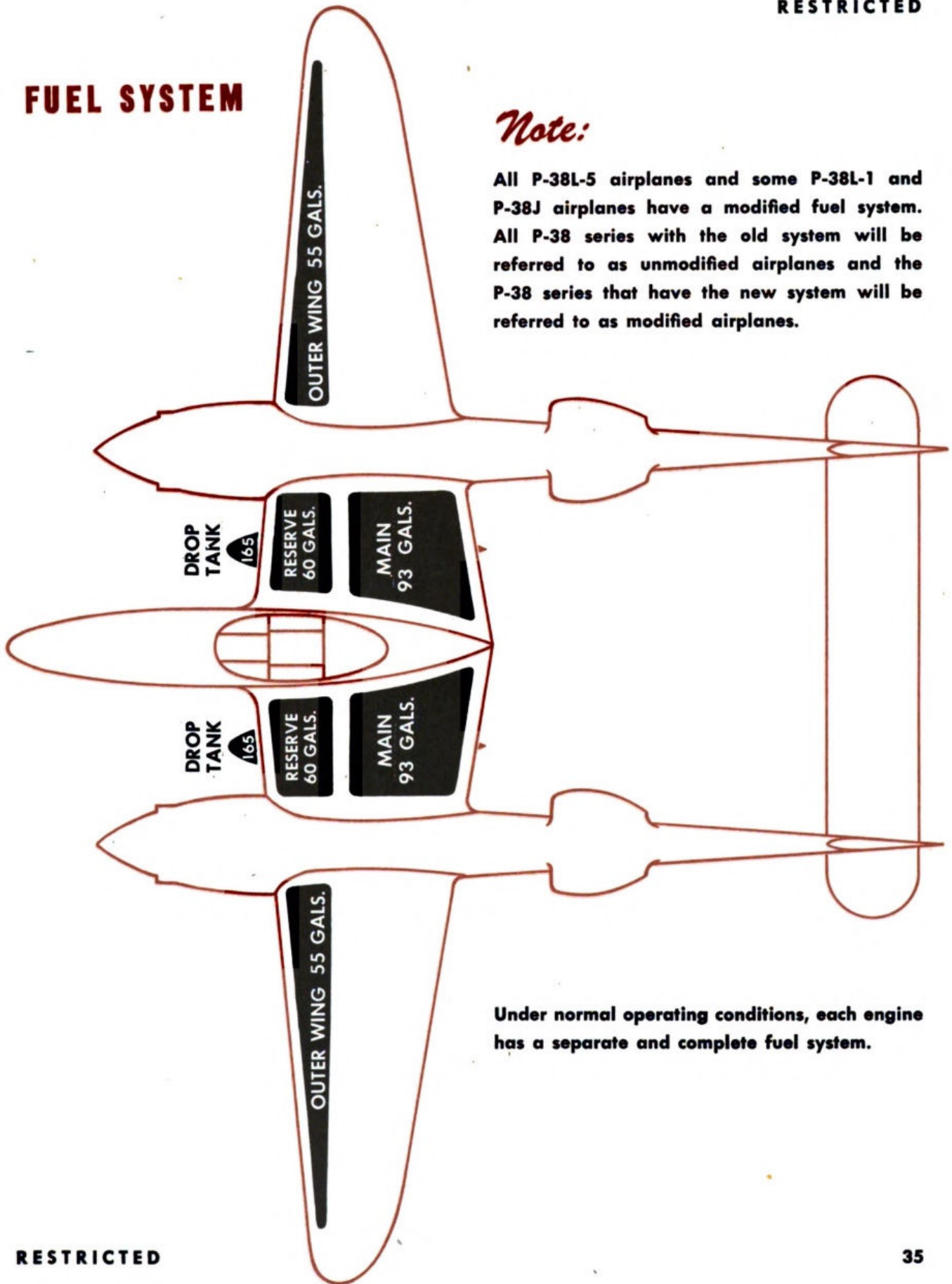

Under normal operating conditions, each engine has a separate and complete fuel system.

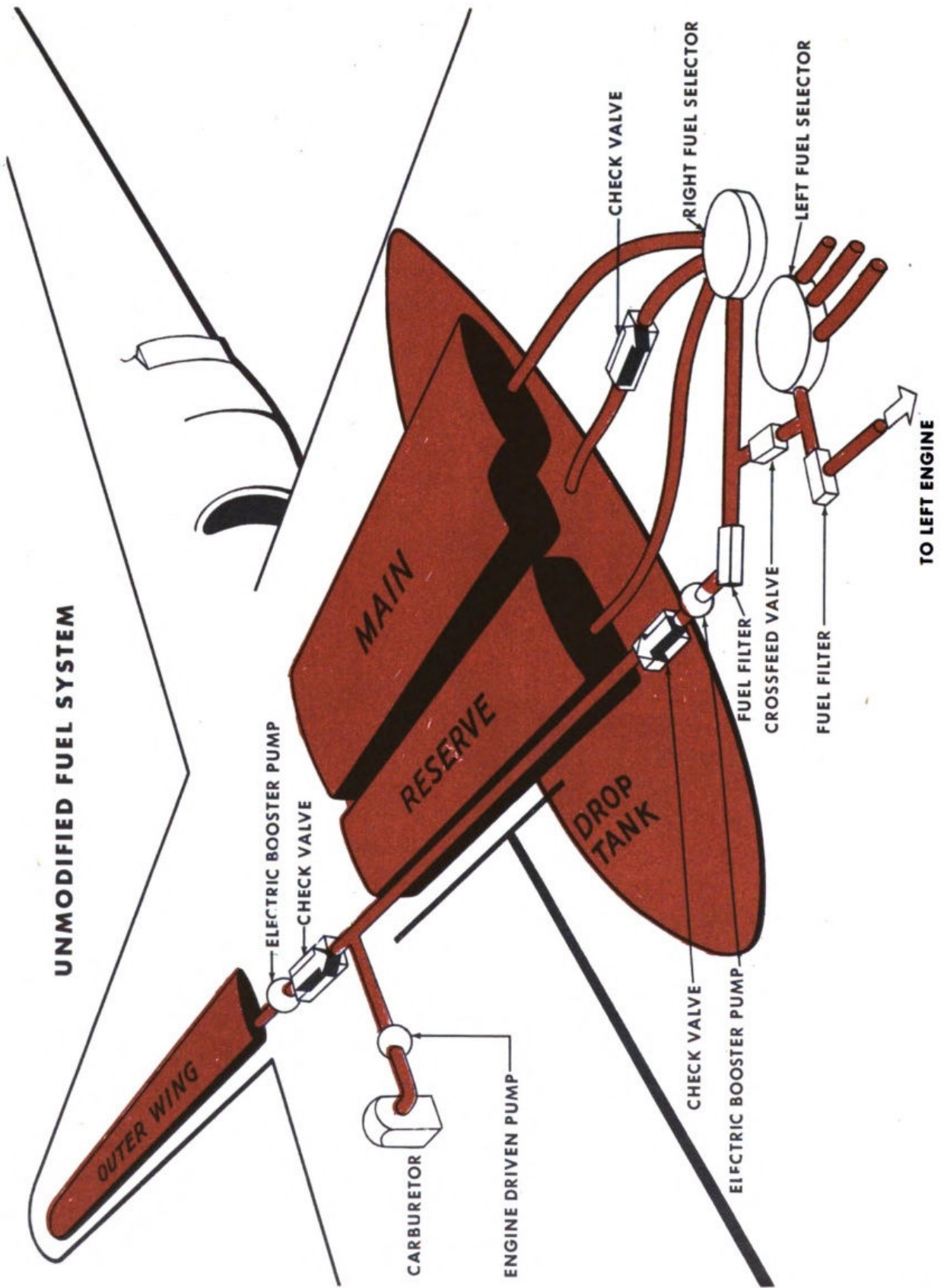

UNMODIFIED FUEL SYSTEM

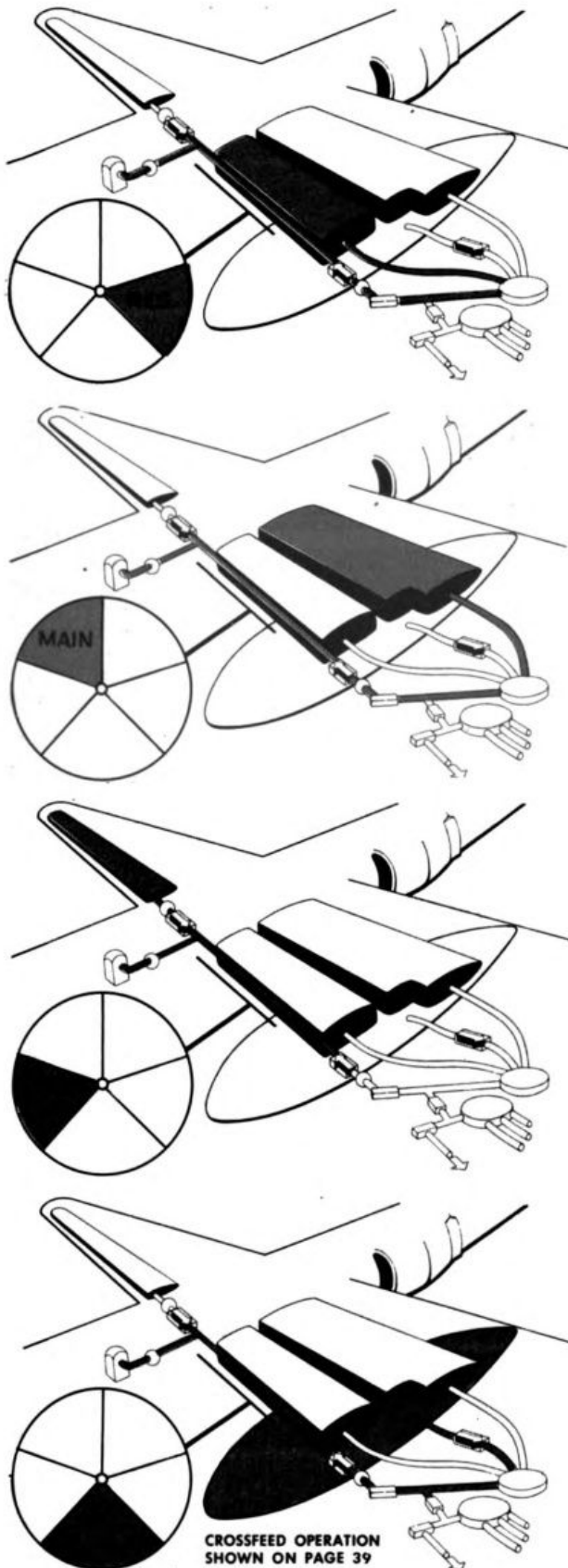

RESTRICTED

### Fuel Pressure

Fuel is supplied to each engine by one engine-driven pump and one electric booster pump. The engine pumps maintain a normal fuel pressure of 16-18 psi up to 12,000 feet. Above 12,000 feet, normal fuel pressure is maintained by the booster pumps.

### Electric Fuel Booster Pump

The electric booster pumps serve for starting the engines, takeoff and landing, flying above 12,000 feet, or in case the engine-driven pumps fail.

The electric booster pumps are controlled by two switches on the left side of the cockpit floor.

### Fuel Tanks

#### P-38 Series Through P-38J-10

There are two reserve and two main self-sealing wing fuel tanks. This normal capacity is more than doubled by the addition of two 165-gallon drop tanks.

#### P-38J-15 Through P-38L-5

In addition to the four standard wing tanks and two drop tanks, these P-38 series have two outer wing tanks with a capacity of 55 gallons each.

The outer wing tanks have their own fuel booster pumps. When you are using fuel from the outer wing tanks, in the unmodified fuel system, turn the regular fuel booster pumps OFF.

### Fuel Quantity Gages

Two fuel quantity gages on the instrument panel indicate only for the reserve and main tanks. The fuel quantity in the drop tanks and outer wing tanks must be estimated by hourly fuel consumption.

Fuel test lights for the outer wing tanks are located forward of the engine control stand. If you are using the outer wing tanks, the warning lights glow when there are approximately 10 to 15 gallons left. Later airplanes have a low level test button so that you can check fuel level in the outer wing tanks before you turn the tanks on.

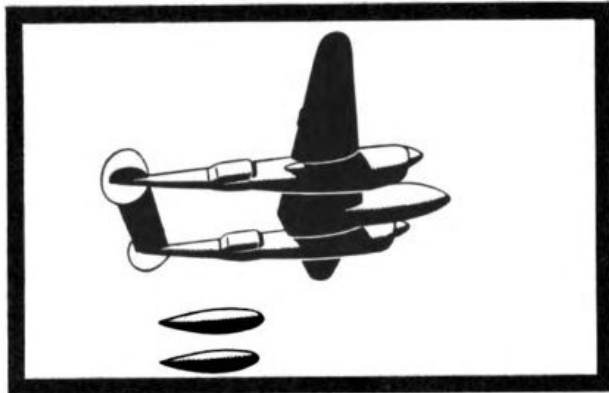

**Drop Tanks**

Beneath each wing is a shackle for carrying an external drop tank (or bomb). Sway braces are added for carrying 330-gallon drop tanks.

You may have to drop the external tanks to lighten your load if an engine fails, or to give you greater maneuverability in combat. Before you drop them, turn the fuel selector valves to the wing tanks.

If you release empty drop tanks at high speeds, they will damage the flaps. Some P-38's have a special brace to prevent this and you can drop the tanks, empty or full, at any speed.

You can drop the tank (or bombs) individually or both at the same time. The release box is on the left side of the cockpit just below the window.

Look around to be sure no one is behind or under you when you release the tanks.

You can release full 165-gallon drop tanks at any speed without damage to the flaps. With the tanks empty, or less than half full, slow down to 150 mph IAS and, at the instant of pressing the release button, pull up. This makes the tanks break clean away from the underside of the wing.

With two full 165-gallon drop tanks, you are carrying an added weight of better than 2000 pounds. The flight characteristics of the airplane remain unchanged, but because of the extra weight, use maneuver flaps for takeoff. Have the drop tank selector switches ON and the arming switch SAFE so you can immediately release the tanks if an engine fails on takeoff.

When you have finished climbing and are on

your way, turn selector switches OFF so that the tanks won't drop if you accidentally hit the release button.

When carrying drop tanks, never exceed 300 mph IAS or make any tight turns.

If you have to turn around soon after takeoff, and land with two full drop tanks, increase the final approach speed by 15 mph and carry partial power until you flare out. The airplane tends to be nose heavy, but a little power will help keep the nosewheel off the ground.

**To Operate Drop Tank (or Bomb) Release**



**OLD**

1. Place arming switch to ARM or SAFE.
2. Place selector switch ON for tank (or bomb) to be dropped.
3. Press the release button.

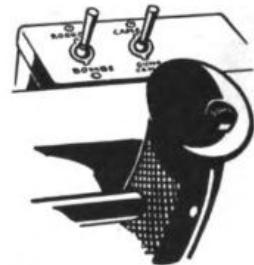
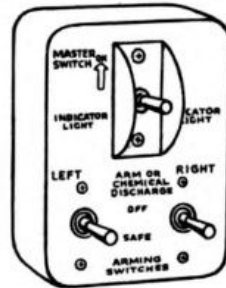

**NEW**

1. Place master switch ON.
2. Place arming switch to ARM or SAFE.
3. Place bomb-rocket switch to BOMBS.
4. Press the release button.

**Note:** Many P-38's have manual releases as a substitute for the electrical release. Check your airplane for their location and operation.

**RELEASE DROP TANKS BEFORE DITCHING OR MAKING A BELLY LANDING**

**Outer Wing Tanks**

The outer wing tanks have their own booster pumps. When you are using fuel from these tanks turn the regular booster pumps to OFF.

**Outer Wing Tank Operation**

**P-38J-15**

Turn the outer wing booster switches to ON, and turn the regular fuel selectors and booster switches to OFF.

**P-38J-20 Through P-38L-1**

Turn the fuel selectors to OUTER WING and turn the booster pumps to OFF.

**P-38L-5**

See Modified Fuel System.

**Crossfeed System**

An electrical crossfeed system makes it possible to feed fuel to either engine from any tank except outer wing tanks. Use the crossfeed sys-

tem when you want to operate both engines from the fuel in one drop tank, or when prolonged single engine flight makes it necessary to draw fuel from the dead engine side.

**Crossfeed Operation**

**P-38 Series Through P-38J-10**

1. Turn the fuel selector to the tank you want to draw fuel from.
2. Turn crossfeed switch to CROSSFEED.
3. Turn the other fuel selector to OFF.

**Note:** Keep your hand on the fuel selector until you are sure both engines are drawing fuel from the desired tank.

**P-38J-15 Through P-38L-5**

1. Turn fuel selector to tank you want to draw fuel from.
2. Turn the other selector to CROSS SUCTION.

CROSS SUCTION or CROSSFEED does not operate for the outer wing tanks.

**CROSSFEED  
P-38 SERIES THROUGH P-38J-10**

**Condition:**  
RH FUEL SELECTOR TURNED TO RESERVE,  
DROP TANK, OR MAIN.  
CROSSFEED SWITCH TO CROSSFEED  
LH FUEL SELECTOR OFF.

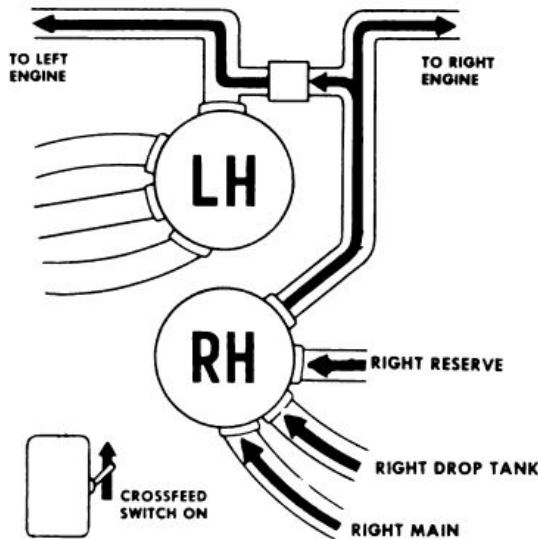

**CROSS SUCTION  
P-38J-15 THROUGH P-38L5**

**Condition:**  
RH FUEL SELECTOR TURNED TO  
RESERVE, DROP TANK, OR MAIN.  
LH FUEL SELECTOR TURNED TO  
CROSS SUCTION.

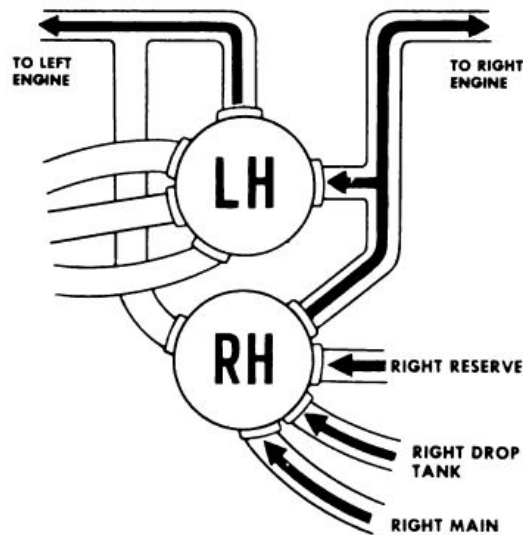



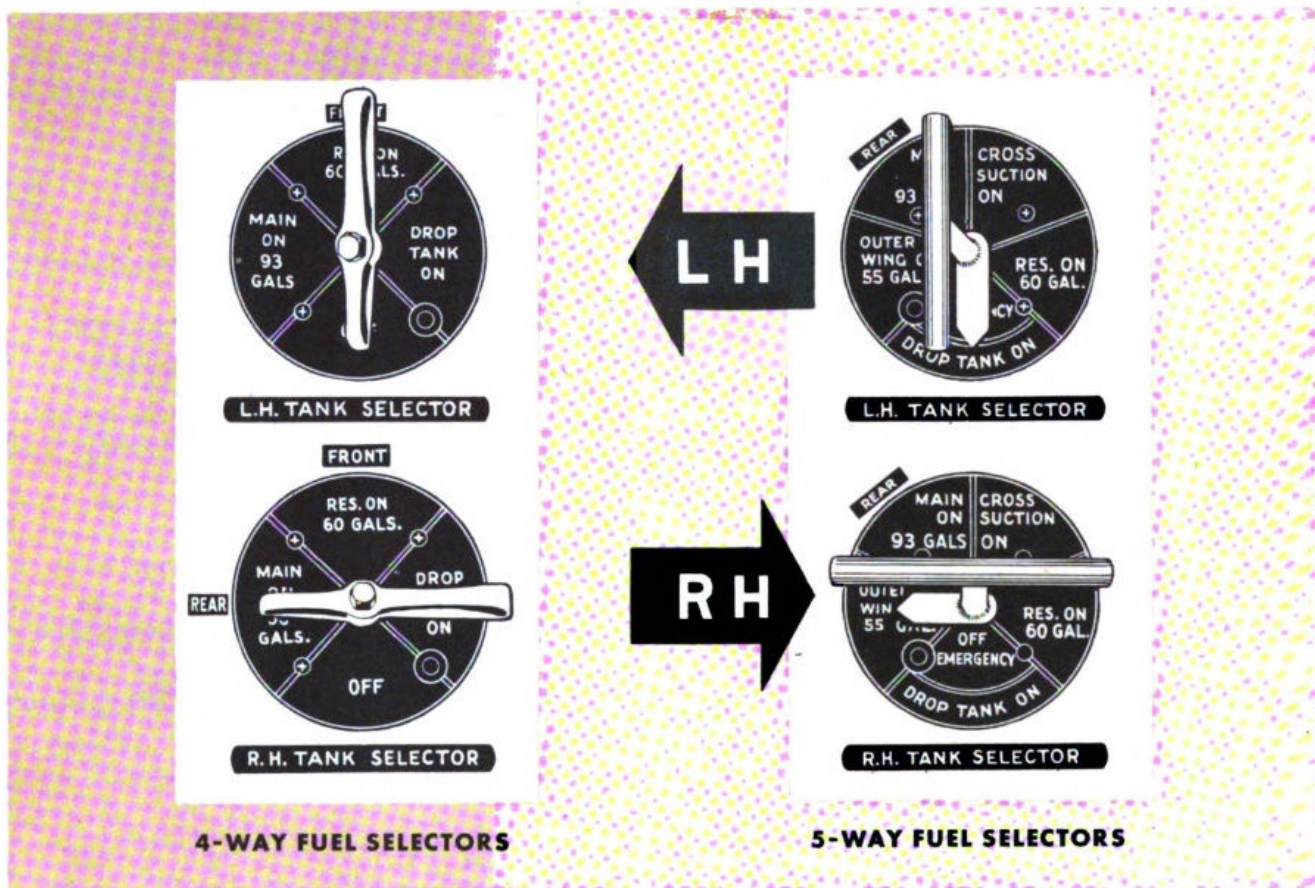

**Fuel Management**

Two fuel selectors are at the left side on the cockpit floor.

**P-38 Series Through P-38J-10**

1. RES (reserve)
2. DROP TANK
3. OFF
4. MAIN

**P-38J-20 Through P-38L-5**

1. MAIN
2. CROSS SUCTION
3. RES (reserve)
4. OFF-DROP TANK
5. OUTER WING

The P-38J-15 also has a 5-position selector, but it has no OUTER WING position. OFF and DROP TANK occupy separate positions on the fuel selector face. The outer wing tanks have separate selectors (there are two toggle switches in back of the electric booster pump control box).

Take off and fly on the reserve tanks for the first 15 minutes. This is necessary because of a bleed-back of unmetered fuel from the carburetors to the reserve tanks. If you use other tanks first, the unmetered fuel goes back to the full reserve tanks, causing the fuel to siphon out. Stop the siphoning by switching to RES (reserve).

Use fuel in the following sequence:

1. Reserve for the first 15 minutes.
2. External drop tanks (if carried).
3. Outer wing tanks (if installed).
4. Main.
5. Reserve.

**Caution!**

When operating at high power settings, especially at altitude, reduce power before switching tanks to prevent the engines from backfiring or stopping.

## Fuel Consumption P-38H, P-38J, and P-38L

GRADE 100

POWER SETTINGS	RPM	HG.	MIXTURE	CONSUMPTION/HR./ENGINE
TAKEOFF AND MILITARY	3000	54"	AUTO RICH	162 GALS.
WAR EMERGENCY	3000	60"	AUTO RICH	180 GALS.
NORMAL RATED	2600	44"	AUTO RICH	115 GALS.
MAXIMUM CRUISE	2300	30"	AUTO LEAN	60 GALS.

### Fuel Consumption

The above figures vary according to the load, trim, and condition of the airplane you are flying. Learn to time the fuel consumption of each tank. Under normal operating conditions, you use approximately 1 gallon a minute per engine. Never run a tank dry.

If you accidentally run a tank dry and the engine stops, do the following:

1. Pull back the throttles.

2. Turn selector valves to tanks with fuel.
3. Turn fuel booster pumps ON.
4. Slowly ease throttles forward. This prevents backfiring and overspeeding propellers.

### *Remember!*

If you run a tank dry on one side, it may be only a short time before you run a tank dry on the other side. Check to be sure the selector is turned to a tank with sufficient fuel.

## Fuel Capacity

	4 WING TANKS	6 WING TANKS
NO DROP TANKS	306 GALS.	416 GALS.
TWO 165-GAL. TANKS	636 GALS.	746 GALS.
TWO 330-GAL. TANKS	966 GALS.	1076 GALS.

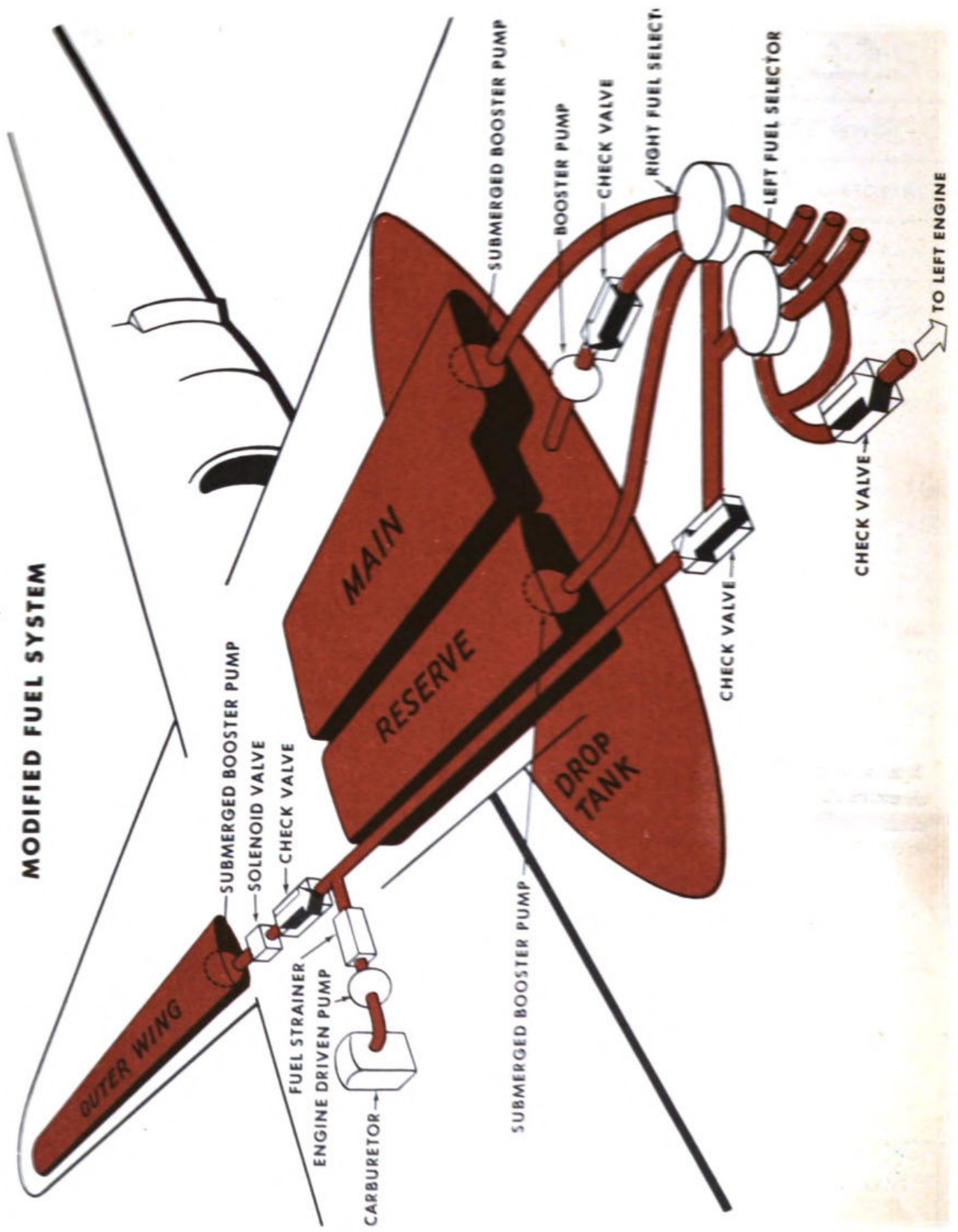

**MODIFIED FUEL SYSTEM**

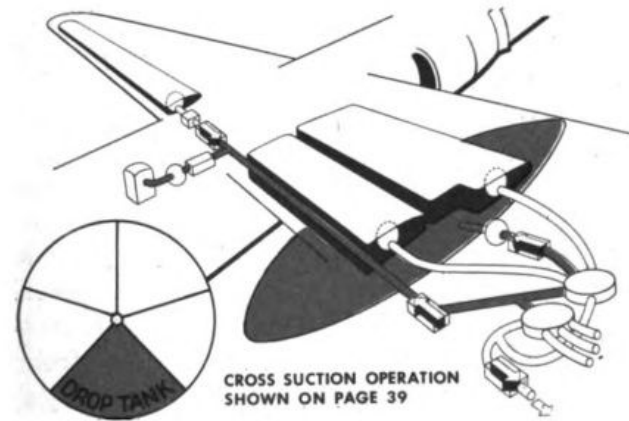
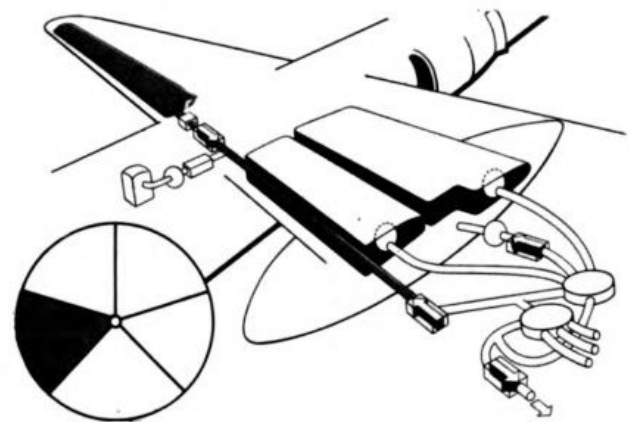
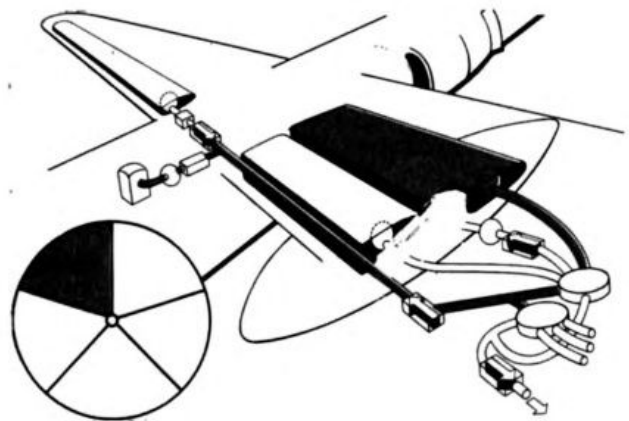
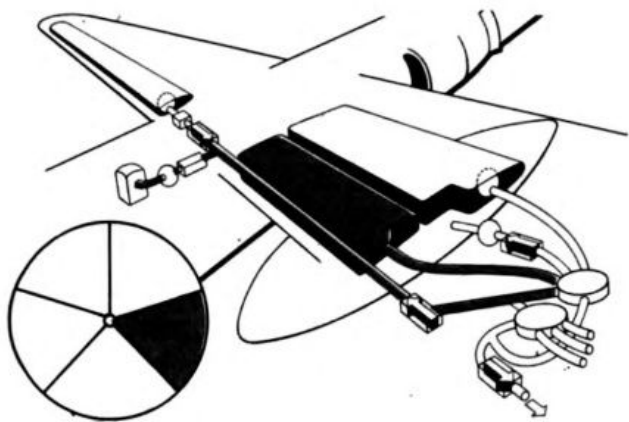

### Modified Fuel System

The P-38L-5 and some P-38L-1 and P-38J airplanes have a pressurized fuel system. Basically the old fuel system hasn't been changed. There are still the same number of tanks in the same location, and the same fuel lines are being used.

In the old unmodified fuel system, the fuel is sucked from the tanks by the engine-driven pumps and the electric booster pumps. In the modified fuel system, the fuel is pumped from the tanks and flows under pressure through the lines to the engine-driven pumps.

### Submerged Pumps

This pressure is developed by small electric submerged booster pumps in each main, reserve, and outer wing tank. When you turn the fuel selector valves to either of the six tanks, the pump in that tank is automatically engaged.

In the old system, you turned the electric booster pumps on for takeoff and turned them off after you established a normal climb. You turned them on again if you were going to fly above 12,000 feet and when coming in for a landing. In the modified system, the booster pumps are on all the time in flight.

Each pump has two speeds, a low speed called **NORMAL** and a high speed called **EMERGENCY**. The low speed, **NORMAL**, is used all the time during normal operation of the engines. Use the high speed, **EMERGENCY**, for takeoff, landing, flying above 10,000 feet, or any time the fuel pressure falls below 14 psi.

Submerged fuel pumps are not installed in the drop tanks. Fuel is forced from the drop tanks at 5 psi by the exhaust from the vacuum pump on the engine. Fuel is routed through a regular booster pump in the line and then to the engine-driven pump.

### Booster Pump Switches

Four switches control the booster pumps. Inspect these switches carefully. Together with the selector valves they are the key to getting fuel to the engines.

The regular booster pump switches are now called master switches. They turn the booster

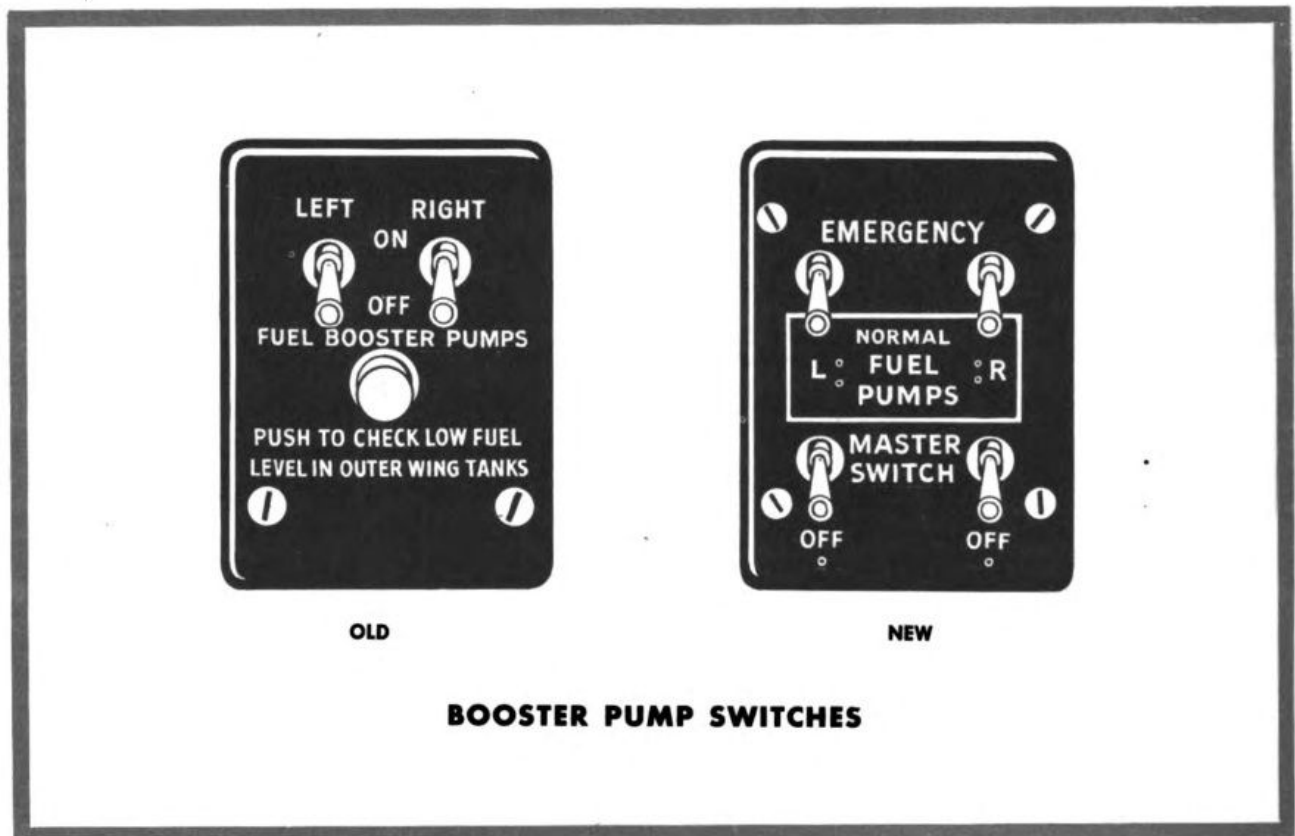

pumps on. Two additional switches, just forward of the master switches, are booster pump speed control switches. They have two positions, **NORMAL** and **EMERGENCY**.

#### Procedure

With the master booster pump switches **ON** and the speed control switches **NORMAL**, you automatically engage the pumps in the tanks selected. For takeoffs, landings, flying above 10,000 feet, and whenever the fuel pressure falls below 14 psi, move the speed control switches to the **EMERGENCY** position. **The master booster pump switches must be ON for the speed control switches to operate.**

#### Booster Pump Check Before Starting Engines

With the engines not running, and the booster pumps **NORMAL**, the fuel pressure indicates between 8 and 11 psi on each tank except the drop tanks. Move the speed control switches forward to the **EMERGENCY** position. The

fuel pressure goes up to 17.5 psi on each tank except the drop tanks. With booster pumps on for drop tank operation the fuel pressure is between 16 and 18 psi. The **EMERGENCY** position has no effect on drop tank pressures.

#### In Flight

If the electric booster pumps fail while in flight, or you turn them off because of electric trouble, the airplane flies satisfactorily below 10,000 feet with normal power while drawing fuel from the main, reserve, or drop tanks. If the generators fail at high altitude the engines will stop. You have to descend to a lower altitude where the engine-driven pumps can supply the engines with fuel.

You cannot draw fuel from the outer wing tanks with the booster pumps **OFF**. The reason for this is that the booster pump switches not only control the pumps in the tanks, but also a solenoid valve in the outer wing fuel lines which must be open before fuel can flow from the tanks to the engines.

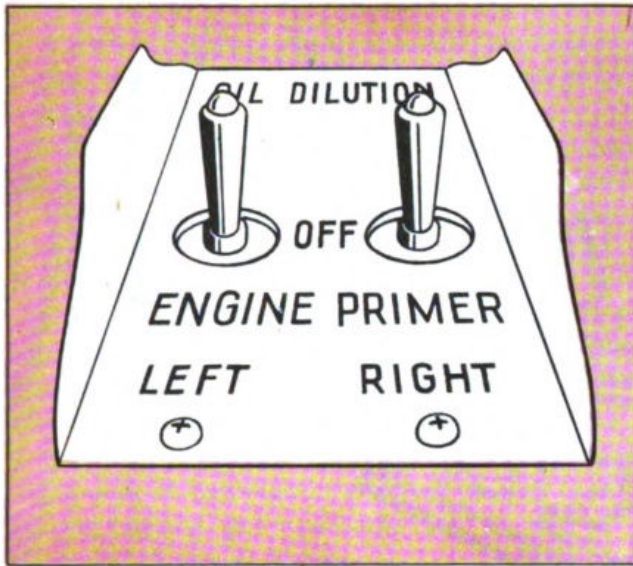

**Electric Primer**

The hand primer has been replaced by an electric primer which is controlled by the same switch as the oil dilution. When you pull this switch back toward you, it primes the engines . . . when you push it forward it dilutes the oil. AN ENGINE CANNOT BE PRIMED UNLESS THE FUEL PRESSURE IS MAINTAINED WITH THE BOOSTER PUMPS.

The amount of priming depends upon temperature conditions, but for moderate temperatures, with the booster pumps on NORMAL, hold the primer switch back for no more than 2 full seconds. Then if you need more after the engine starts turning over, prime as needed. Avoid over-priming!

Over-priming can damage an engine and is definitely a fire hazard.

**Fuel Selector OFF Position**

The fuel selector valves on early P-38 series have an OFF position but on later series the DROP TANK position and the OFF position have been combined. So if you are carrying drop tanks with fuel there is no OFF position for the selectors. If you have an engine fire in flight and are carrying loaded drop tanks, release the drop tank on the bad engine side and turn the selector to DROP TANK.

Another way to stop the fuel supply to an engine is to turn the selector to the OUTER WING tank position and turn off the booster pump master switch of that engine. With the booster pump OFF, you cannot draw fuel from the outer wing tank because a solenoid valve in the line from this tank is closed.

To shut off fuel to both engines simultaneously, turn both selector valves to CROSS SUCTION. This is particularly convenient for shutting off fuel on the ground when drop tanks are installed.

The improved modified fuel system is found only on recent P-38s. You can tell if your P-38 has this system by checking for the following identifying characteristics:

1. The fuel booster pumps are operated by 2 sets of switches—MASTER and NORMAL—EMERGENCY.
2. Electric priming switches have replaced the old hand primer.

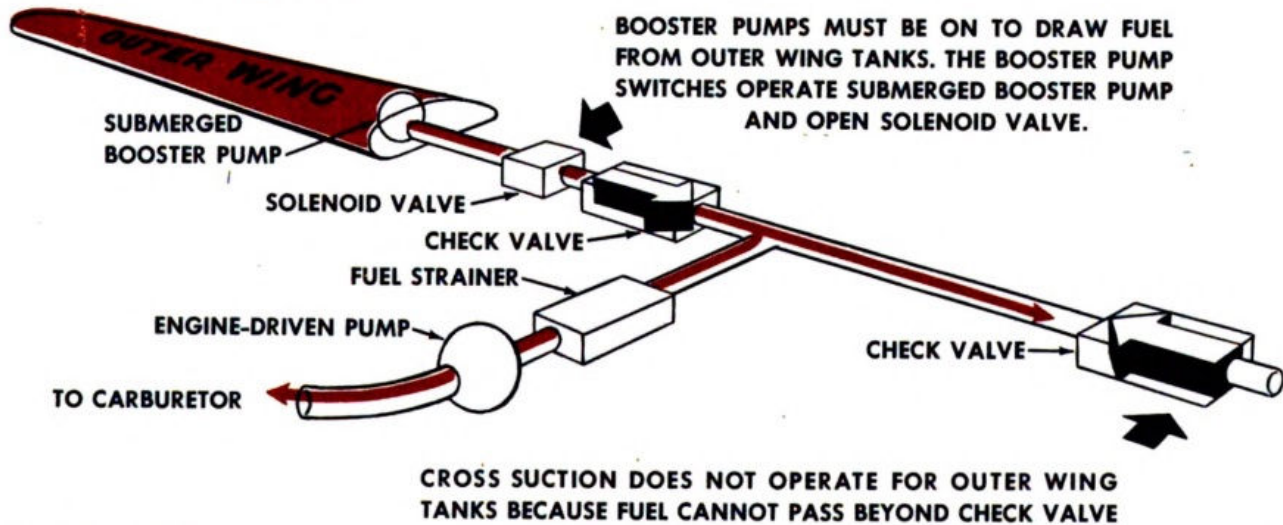

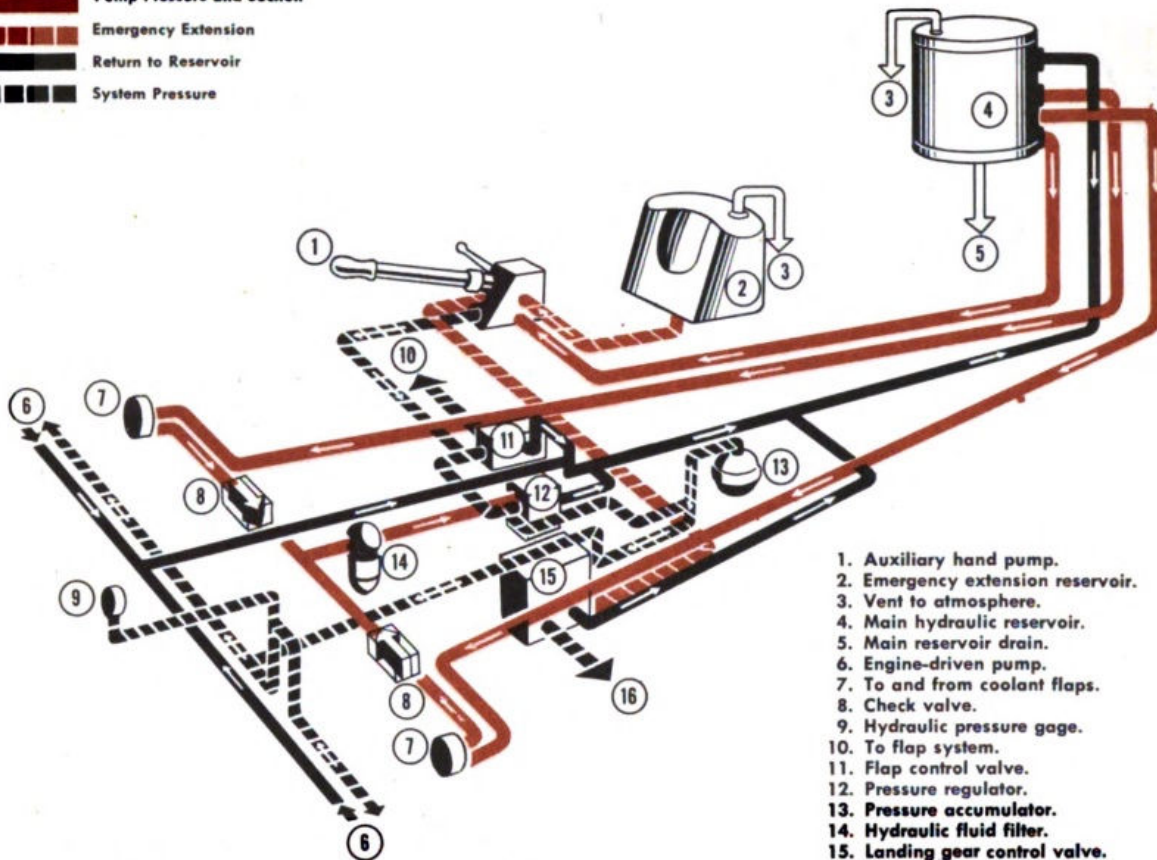
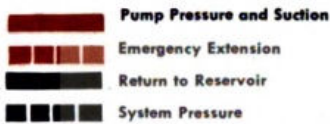

1. Auxiliary hand pump.
2. Emergency extension reservoir.
3. Vent to atmosphere.
4. Main hydraulic reservoir.
5. Main reservoir drain.
6. Engine-driven pump.
7. To and from coolant flaps.
8. Check valve.
9. Hydraulic pressure gage.
10. To flap system.
11. Flap control valve.
12. Pressure regulator.
13. Pressure accumulator.
14. Hydraulic fluid filter.
15. Landing gear control valve.
16. To landing gear system.

## THE HYDRAULIC SYSTEM

The hydraulic system operates the landing gear, wheel well doors, wing flaps, and coolant shutters. The brakes are operated by a separate hydraulic system.

Hydraulic pressure is maintained by engine-driven pumps mounted one on each engine. Normal hydraulic pressure is between 1100 psi and 1400 psi. In later series a surge up to 1600 psi is permissible if it drops back to 1500 psi or less.

The system operates all the hydraulic equipment (except the brakes) using power from the engine-driven pumps and fluid from the top half of the main hydraulic reservoir.

### Auxiliary System

The auxiliary system operates the same equipment and uses the same lines as the normal system. The difference is that the hand hydraulic pump furnishes the power, and the fluid comes from the bottom of the main hydraulic reservoir.

**You can't build up pressure with the hand hydraulic pump unless the aileron boost valve and coolant override switches are in the OFF positions.**

### Emergency Extension System

The emergency extension system operates from a separate reservoir and through separate lines, using the hand pump for power. **The only purpose of this system is to extend the landing gear in case of complete failure of the other two systems.** Since this system works off a separate set of hydraulic lines, there is no indication of pressure on the hydraulic pressure gage.

**Hydraulic Pressure Gage**

A hydraulic pressure gage, on the instrument panel, shows you if the hydraulic system is working properly.

When the hydraulic system is not in use, the pressure gage registers approximately 1300 psi.

When the hydraulic system is in use, the pressure gage drops from 1300 psi to the difference in pressure remaining in the lines.

Use the hydraulic gage as a check for the correct operation of the landing gear and flaps. For example, when you lower the landing gear, the hydraulic system is put into operation. The pressure gage then drops from 1300 psi to the difference in pressure remaining in the lines. If the landing gear requires 600 to 800 psi

to be lowered and locked, the pressure gage will indicate between 500 and 700 psi. When the gage returns to its normal reading you know the landing gear is down and locked.

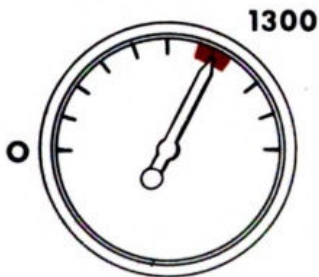

**GEAR UP  
AND LOCKED**

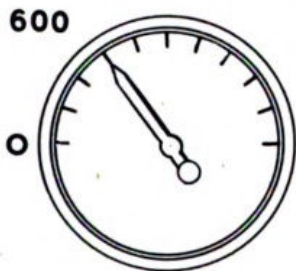
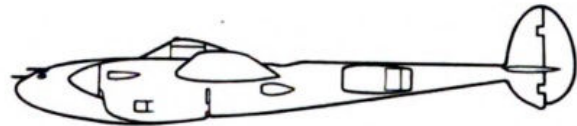

**GEAR GOING  
DOWN**

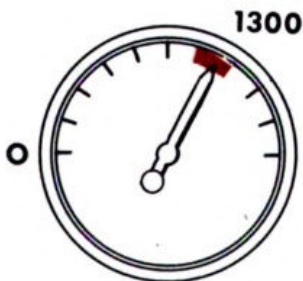
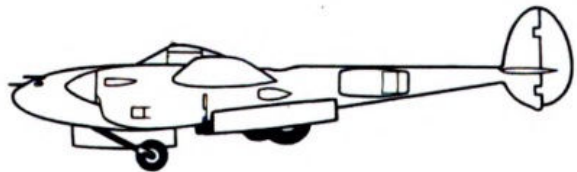

**GEAR DOWN  
AND LOCKED**

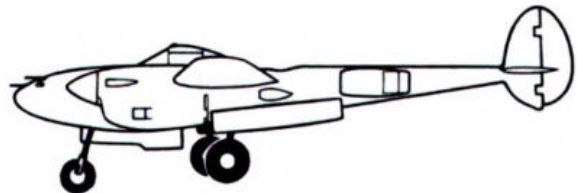



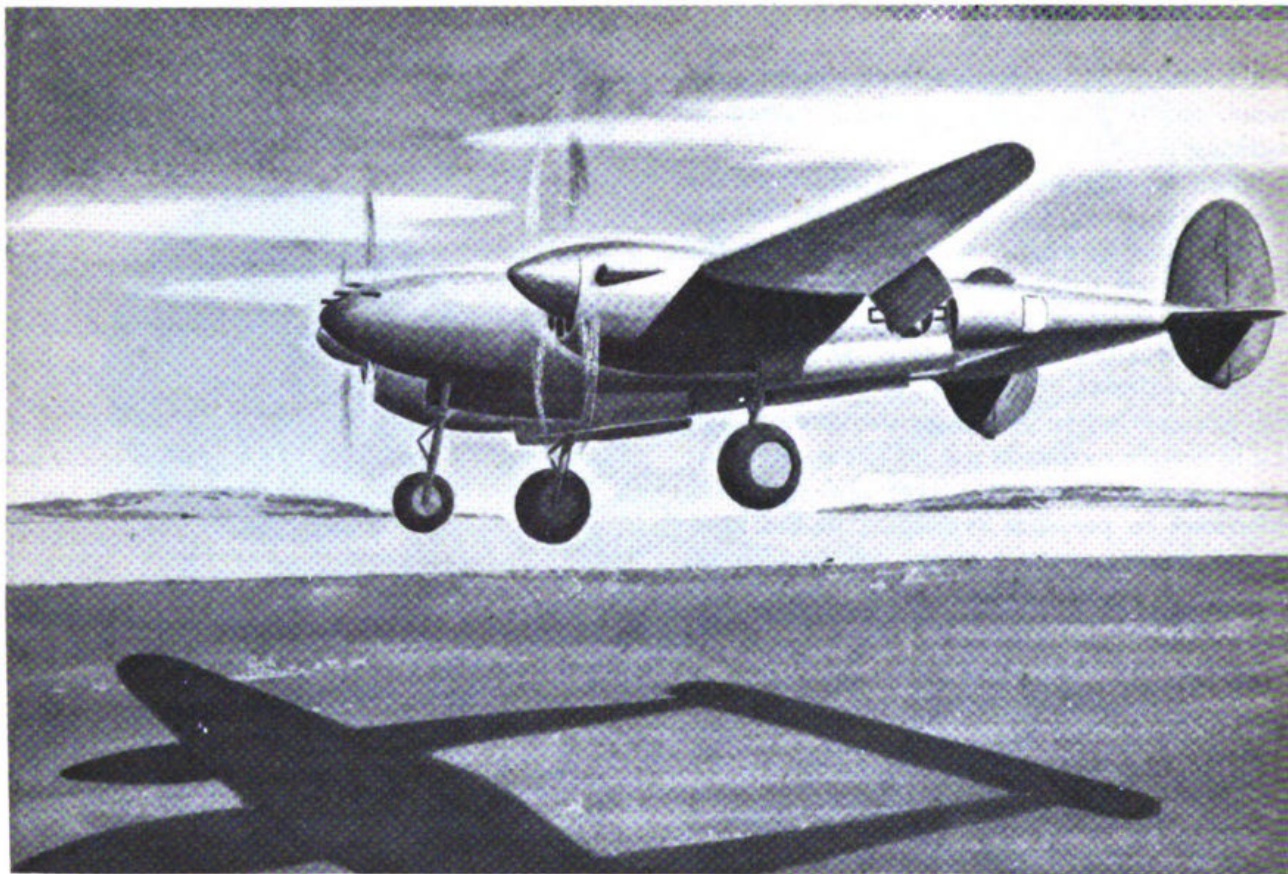

## THE LANDING GEAR

The P-38 has a retractable tricycle landing gear. It is hydraulically operated and is controlled by a lever on the left-hand side of the cockpit. The lever has only two positions: UP and DOWN.

There is a safety device that prevents you from raising the landing gear lever while the main struts are compressed. This prevents retraction of the gear while the plane is on the ground.

**Don't try to lift the landing gear handle while the plane is on the ground.**

On P-38 series before the P-38 J-15, when the throttle is retarded to 15" Hg. or less, a warning horn sounds and a landing gear warning light on the control stand comes on if the gear is in any position other than down and locked. **The P-38J and P-38L do not have a warning horn.** The warning light is on the instrument panel and glows if the landing gear is not locked in

either the up or down position. The P-38 series through the P-38J-10 has a position indicator on the instrument panel for the landing gear and flaps.

The hydraulic pressure gage normally registers 1300 psi. When you put the hydraulic system into operation by raising or lowering the landing gear, the pressure drops to the difference in pressure remaining in the lines. When the operation has been completed and the gear is either up or down and locked, the pressure indicated on the hydraulic gage returns to 1300 psi. Use the hydraulic pressure gage as a check that the gear is down and locked.

### Shimmy Damper

The shimmy damper prevents the nosewheel from vibrating excessively. Should the device ever fail during taxi, takeoff run, or landing roll, you'll encounter severe vibration. Stop as soon as possible. The nosewheel may collapse.

### Operation of the Landing Gear

When you put the control handle in the UP position the gear rises.

If, after takeoff, you cannot raise the lever to the UP position, turn the emergency release knob counter-clockwise with your left thumb. The emergency release knob is just forward of the landing gear lever.



The wheel well doors close when the landing gear reaches its retracted position. In the last quarter inch of travel, the main strut strikes a sequence valve actuating a hydraulic unit that closes the doors.

You can see if the main wheel doors are closed by looking over your shoulder at the bottom section of each boom. If the gear comes up but the doors remain open, pump the stick forward. This causes the gear to press up against the sequence valve and close the doors. If that doesn't work, try lowering and raising the gear again. If the doors continue to remain open, return to your base and land. With wheel doors open or gear extended you must never skid the airplane or exceed 175 mph.

### To Retract the Landing Gear

Don't raise or lower the landing gear in a turn. The centrifugal force will put a strain on the hydraulic system.

1. Place landing gear control handle in UP position.
2. Look over your shoulder to see if the main wheel doors are closed.
3. Check that hydraulic pressure has returned to 1300 psi.
4. Check if wheels are up by hand hydraulic pump.

The loud, popping noise under the seat is the pressure regulator valve, and the smoke that may come in the cockpit when the gear is raised is caused by the nosewheel rubbing on the nosewheel door. There is no cause for alarm in either case.

**If the gear does not retract with the lever in the UP position, return the lever to the DOWN position and land.**

### To Lower Landing Gear

1. Slow the airplane to at least 175 mph.
2. Place landing gear control lever in the DOWN position.
3. Look over your shoulder to see if the main wheel doors are open.
4. Check nosewheel position by the polished spot on the engine cowling.
5. Make sure the pressure indicator gage has returned to 1300 psi.
6. Test hand pump to make sure it resists operation.
7. Check that landing gear warning light is off.

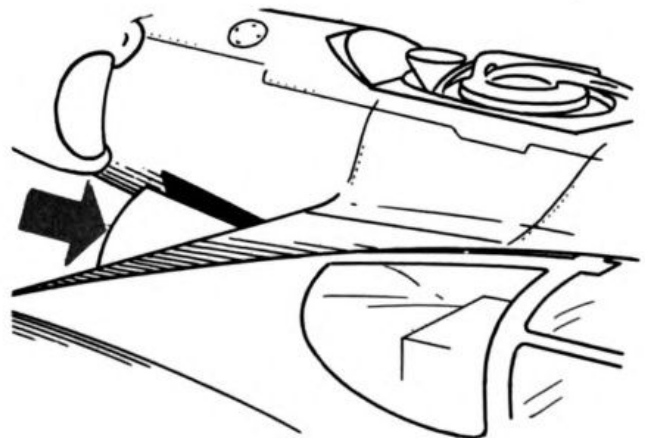

**CHECK MAIN WHEEL DOORS BY LOOKING OVER SHOULDER**



## WING FLAPS

The P-38 has Fowler type flaps which slide out of the trailing edge of the wing. Using up to  $\frac{1}{2}$  flaps increases the wing area and provides greater lift. When the flaps are from  $\frac{1}{2}$  to full down, they act as air brakes.

The flaps are operated by a hydraulic motor located behind the pilot's seat. The motor makes a whining noise which, when you first hear it, may startle you.

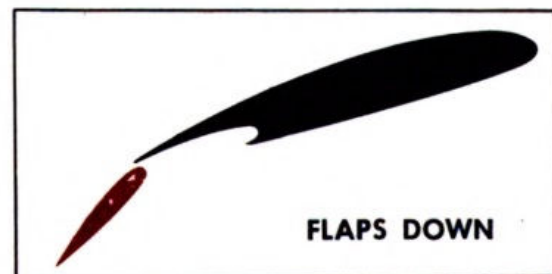

**Operation**

The flap control lever is on the forward right-hand side of the cockpit. The UP, DOWN, and MANEU. (Maneuver) positions control the direction of flap movement. The CLOSED position enables you to stop the motion and lock the flaps in any desired intermediate position.

On late P-38 series, the flap position is indicated by a small, pop-up lever on the trailing edge of the left wing just inside of the boom. This indicator projects above the wing whenever the flaps are not full up.

To lower the flaps, move the control lever to the DOWN position. The lever will not go to the DOWN position until the trigger on the lever is lifted through the notch forward of the CLOSED position. Return the lever to the CLOSED position when you have the desired amount of flaps.

To raise the flaps, move the control lever to UP.

When not in use, leave the control lever in the CLOSED position.

Don't lower full flaps at airspeeds over 150 mph IAS, or maneuver flaps over 250 mph IAS.

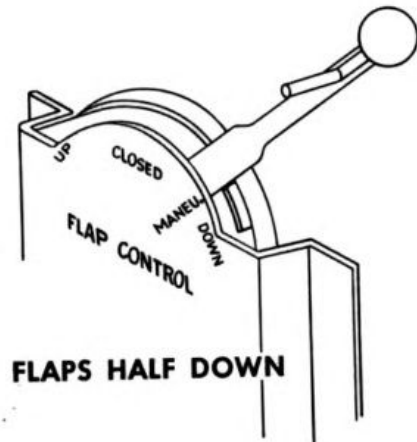

**FLAPS HALF DOWN**

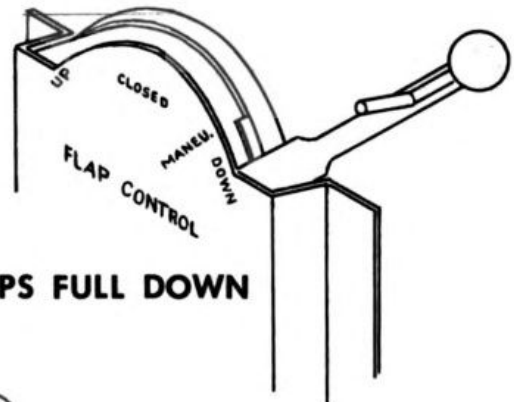

**FLAPS FULL DOWN**

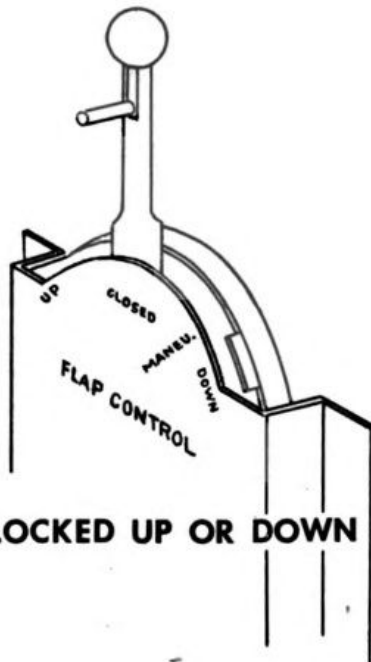

**FLAPS LOCKED UP OR DOWN**

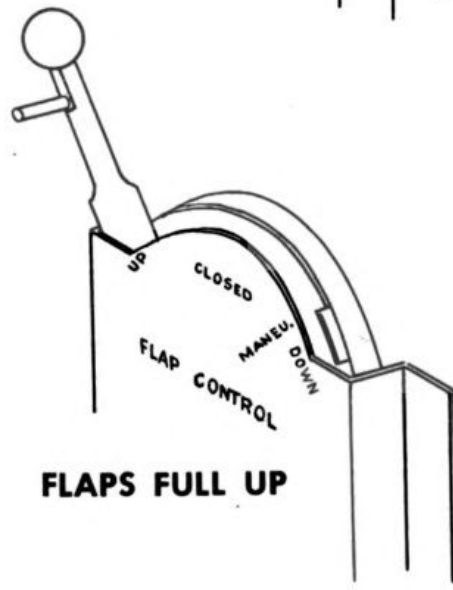

**FLAPS FULL UP**

## RESTRICTED

### Maneuver Flaps

Pull the flap control lever back to the MANEU. position without lifting the trigger through the notch, and you get maneuver flaps (approximately  $\frac{1}{2}$  flaps). One-half flaps increases lift and lowers the stalling speed. This provides the P-38 with greater maneuverability.

You can lower maneuver flaps, also known as combat flaps, at airspeeds up to 250 mph IAS.

### Dive Flaps

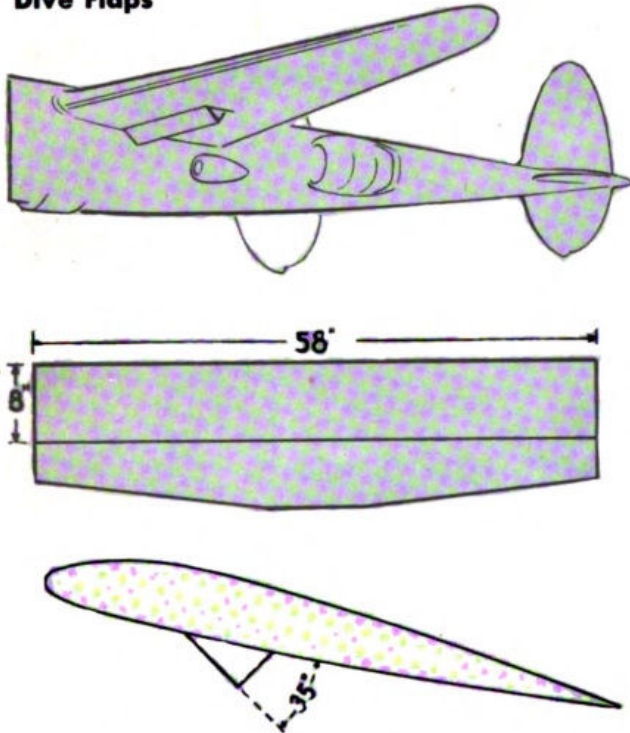

The P-38L and later P-38J series have dive flaps. They are just behind and below the leading edge of the wing, outboard of the engine nacelles. They are approximately 58 inches long and 8 inches wide.

The flaps are electrically controlled by a toggle switch on the left-hand side of the control wheel.

The dive flaps are either up or down. There is no intermediate position. They extend or retract within 2 seconds and have a  $35^\circ$  angle when in the down position.

### Aileron Boost

Another new addition is the aileron boost. It is exactly what its name implies. It is hy-

draulically operated and triples the rate of roll. The aileron boost control is on the right side of the cockpit. It has two positions: ON and OFF.

Aileron boost makes the P-38L and later P-38J's extremely maneuverable at any speed.

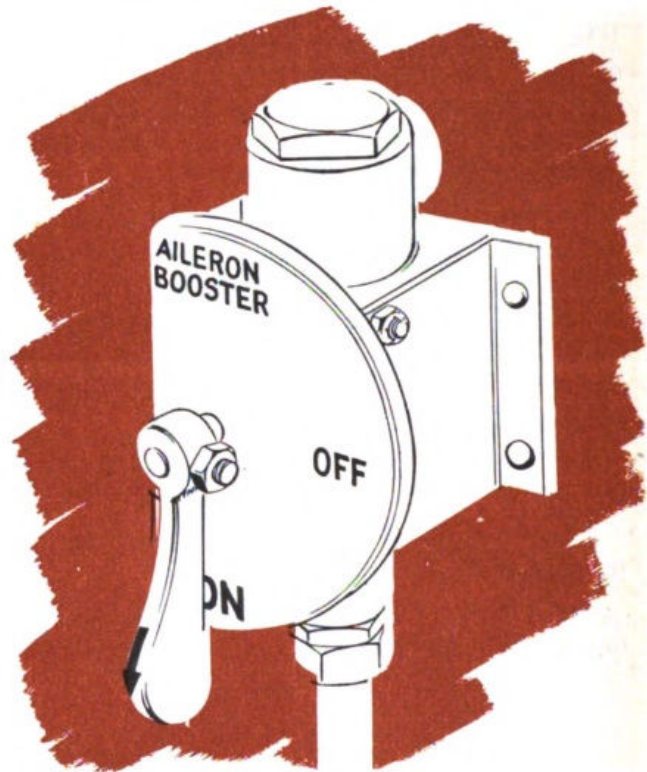

**Aileron boost must be ON all the time except for the following conditions:**

**Single engine landing.**

**Hydraulic trouble.**

**Aileron boost failure.** If the aileron boost unit fails, you may not be able to overpower its control. Immediately turn the aileron boost control valve OFF.

**Note:** The ailerons ride approximately 1 inch higher with boost OFF. This change in trim is normal.

### *Warning!*

**Do not turn aileron boost ON during flight. If you have started a flight with aileron boost OFF, or have turned it OFF for emergency operation, don't turn it ON again until you have landed.**

## ELECTRICAL SYSTEM

The electrical system consists of one 100-ampere generator mounted on each engine, a voltage regulator, a reverse current relay, a battery in the left boom (in the nose compartment of the F-5), a battery switch, two generator switches, two ammeters, and a voltmeter. Earlier P-38 series had only one generator mounted on the left engine.

The generators are the primary source of power for all electrical equipment. Be sure the generators are on at all times.

The voltage regulator keeps the generator voltage constant. A constant voltage of 28 volts is necessary to operate the electrical equipment and keep the battery charged.

The reverse current relay automatically disconnects the generator from the main circuit when the engine stops or the generator fails.

The battery is a small power unit used for starting the engines and a reserve to supply electrical power if the generators fail. Don't use the battery as a primary source of power. With the electrical equipment on and the generators off, the battery won't last longer than 30 minutes. Be sure the generators are on and working properly.

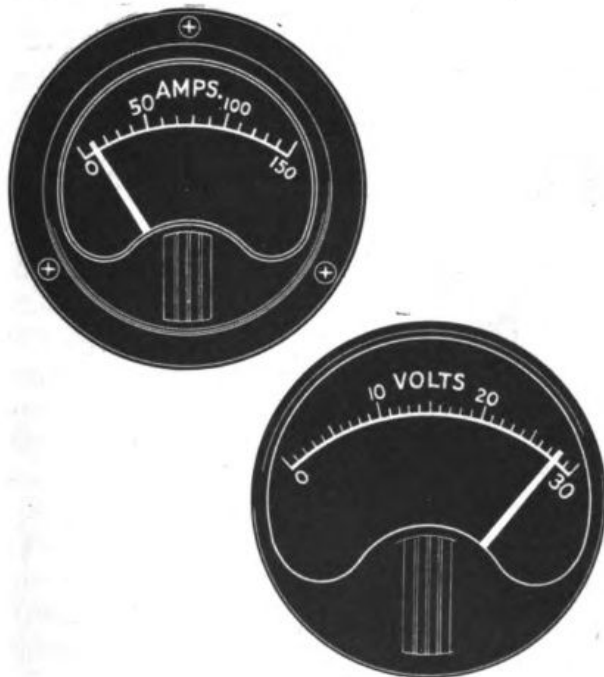

RESTRICTED

The battery switch connects and disconnects the battery from the main circuit.

The generator switches connect and disconnect the generators from the main circuit.

The ammeter indicates the charging current to the battery and the electrical system. Reading for the ammeter generally fluctuates below 50 amps.

The voltmeter indicates the voltage output of the generators. In the P-38L and later series, the voltmeter is an indication of the voltage output of the battery as well as the generators. In these later series, the voltmeter can't be used as an indication of generator failure. Any deviation greater than a half a volt, plus or minus, from a reading of 28 volts on the voltmeter is reason to check the condition of the voltage regulator or the generators. The generators don't cut into operation until you have approximately 1600 rpm or over and you will not receive an indication of 28 volts unless your rpm is that high.

### Inverter

An inverter supplies current to specific instruments. The inverter switch is located either on the main switch box or directly under the flap control handle. The inverter must be on. Many P-38's up to and including the P-38H have an inverter warning light installed. When the light is on, the inverter is not in operation.

The inverter on the P-38J and P-38L operates only the remote compass. There is no warning light. Turn on the inverter by a switch on the main switch box labeled COMPASS; ON-OFF.

### Circuit Breakers and Fuses

The circuit breakers mounted along the right side of the cockpit on later series P-38's act as fuses and automatically break the circuit when an overload occurs. They replace the fuses in the nosewheel well in earlier series. Reset a circuit breaker by allowing a short interval for cooling and then pushing the button. Unlike the propeller circuit breakers, these buttons do not pop out and it is not possible to tell by looking at them whether or not a circuit breaker is open.

53

# COMMUNICATIONS

Most P-38's have a VHF command radio, and an IFF (Identification, Friend or Foe) set.

## VHF Command Set (SCR-522-A or AN/ARC-3 Radio)

The transmitter and receiver operate on four pre-tuned channels. It is a powerful radio, having a range of more than 150 miles. It transmits and receives on direct line of sight. If there are any obstructions between you and the airplane or station you are calling, your transmission will not be received.

The control box is on the right-hand side of the cockpit. There are 5 push buttons on the control box. The first one is the OFF button. The others, A, B, C, and D, turn on the transmitter and receiver and select the frequency.

The control box also has a lever that varies the intensity of the channel indicator lights, and a T-R-REM switch. When the T-R-REM switch is set to T, you can transmit but not receive. When it is set to R, you can receive but not transmit. When it is set to the REM position, you have remote operation and can transmit and receive. The T and R positions are for emergency operation. The T-R-REM switch is usually wired to the REM position.

With the T-R-REM switch in the REM position, you can transmit by pressing the microphone button on the control wheel.

You use a throat microphone or an oxygen mask microphone with this radio. Be sure the jacks are plugged in properly and you have checked all your equipment.

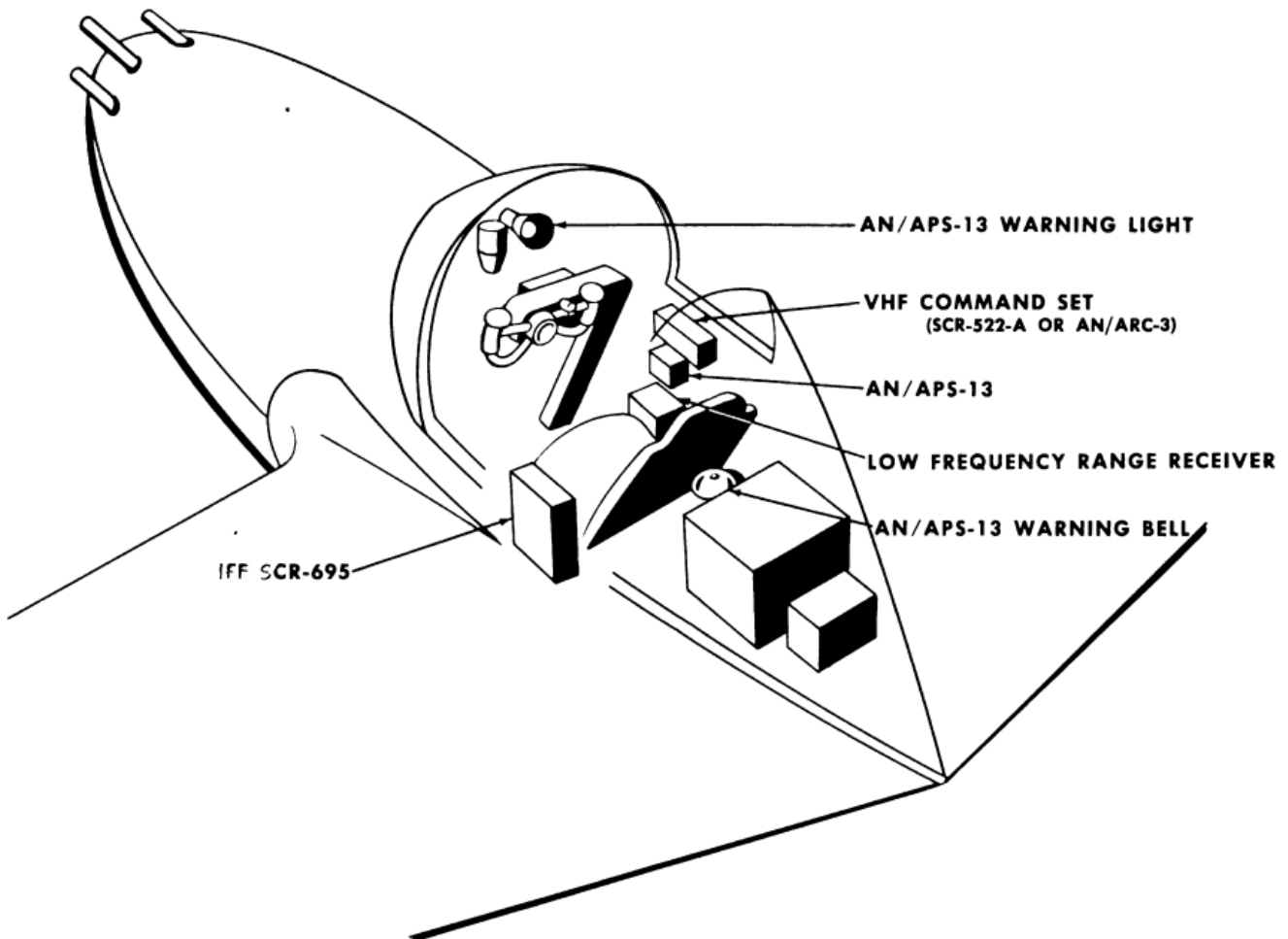

### Operation of the Radio

1. Airplane battery switch ON.
2. Make sure your headset and microphone are plugged in jacks.
3. Control switch in REM position.
4. Press A, B, C, or D channel button as desired.
5. To transmit, press microphone button. Speak slowly and clearly.
6. To turn radio equipment off, press OFF button.

## Caution

Voltages developed by transmitters are sufficiently high to cause severe burns or death. Before you transmit on the ground, be sure no one is close to the antenna.

### Low Frequency Radio Range Receiver

Some P-38 series have a low frequency range receiver. It operates independently of the VHF and can be used at the same time. The set is on the right side of the cockpit below the VHF radio switch box.

To operate:

1. Turn the set on. Switch is on the face of the set.
2. Turn volume up until you hear the background noise.
3. Tune to desired frequency.

### AN/APS-13 Radio Warning System

This equipment provides a visible and an audible warning of the presence or approach of other aircraft from behind. It should be turned off from takeoff up to approximately 3000 feet and when coming in for a landing. If the equipment is on below 3000 feet, a warning indication is given because of the reflection of radio waves from the ground.

A red light, mounted to the right of the gun sight, lights up and a warning bell rings to warn you of other aircraft within range of operation of the equipment. You receive a warning indication regardless of whether the aircraft within range is friendly or enemy.

RESTRICTED

An ON-OFF switch and dimmer control are on the right side of the cockpit below the recognition light switches. Use the dimmer control to adjust the brilliance of the red indicator light.

You can test, in flight, if the radio warning system is operating. Move the ON-OFF switch to ON, wait at least 3 minutes for the tubes to warm up; then, hold the test switch ON. If the red indicator light glows and the bell rings, the equipment is operating properly.

# IFF

## *Identification Friend or Foe*

### SCR-695 Radio

The receiver for the IFF is in the right boom, between the coolant radiators and the baggage compartment.

The control box is on the left-hand side of the cockpit. It contains an ON-OFF switch and a 6-position selector switch. To turn the IFF equipment on, place the ON-OFF switch in the ON position. Your communications officer will instruct you concerning the correct selector switch settings.

### Destructor Unit

The IFF equipment is secret. If you make a forced landing in enemy territory, destroy the IFF. Two push button switches are located directly below the control box. They are operated by current from the airplane electrical system. When you press both buttons simultaneously, you destroy the receiver in the tail boom. **The receiver is destroyed but nothing else!**

If you bail out or make a crash landing, the IFF will automatically be destroyed when the airplane hits the ground. The destructor unit is set to go off automatically when 6 G's or more are applied.





## OXYGEN

You have a low pressure, demand type, oxygen system. It is important that you understand the oxygen system and the use of the oxygen mask. Check with your personal equipment officer and flight surgeon concerning the use and fit of your mask. Know the symptoms and danger of anoxia.

### The Mask

You have either an A-10 or A-14 demand type oxygen mask. Both work perfectly on this system. Fit the mask snugly. Check it for leaks by holding your thumb over the end of the hose and breathing in gently. If you find it difficult to breathe, it is a good fit. Wash your mask after each use and inspect it regularly.

### The System

There are 3 oxygen bottles in your airplane; 2 in the left boom and 1 in the right. The bottles are filled to a pressure of 400 to 450 psi. This gives you more than a 6-hour supply of oxygen at 30,000 feet. A pressure gage on the left side of the cockpit near the landing gear control handle indicates the amount of pressure in the system. A supply warning light indicates when the pressure drops below 100 psi.



There is an oxygen regulator with an auto-mix lever. The lever has 2 positions: ON and OFF. When the lever is in the ON position, the regulator automatically mixes air with the oxygen to give you the supply you demand at any altitude. With the auto-mix lever in the OFF position, you receive pure oxygen every time you inhale.

A small knob for emergency use is on the regulator. By turning the knob counter-clockwise you convert the demand system to free flow. This allows oxygen to flow at a steady rate whether you inhale or not. **Use it only if the demand system fails.**

A flow meter on the regulator indicates that the system is operating properly. It is a blinker that opens and closes as you breathe.

### How to Use the Oxygen System

Plan to use oxygen on all flights above 12,000 feet. Breathe normally whenever you use oxygen. Only a certain amount of oxygen can be absorbed. When the blood becomes saturated, the rest is wasted.

1. After you are in the cockpit, connect your mask to the tube leading to the regulator. Be sure the connection is a snug fit. Test it and see that it doesn't separate easily.

2. Clip the mask tube to your clothing, allowing for head movement without pulling the mask or tube loose.

3. Turn the auto-mix lever ON and be sure the emergency knob is OFF.

4. Constantly check the pressure and flow during flight.

5. Turn the auto-mix lever OFF at 30,000 feet and over.

At 30,000 feet you receive pure oxygen with the auto-mix lever either ON or OFF. But with it OFF you are abruptly informed when the supply is exhausted because you can't get an-

other breath through the mask. It feels as if someone has put a finger over the end of the tube. This is your warning to get down to a safe altitude where oxygen isn't needed. If you leave the auto-mix lever in the ON position and the supply is exhausted, you would continue to breathe as before, but the regulator would be supplying nothing but cockpit air. After a few minutes of such breathing you would be overcome by anoxia.

### Emergency System

If the supply warning light comes on, immediately descend to below 12,000 feet. A leak in the system can cause a very rapid loss of oxygen.

If the flow meter (blinker) stops but you still have oxygen pressure, immediately check your mask for fit and the tube connection. If this doesn't start the flow meter, the demand part of the system has probably failed. Turn the emergency knob to ON. The oxygen supply under these conditions depletes rapidly, so start your descent to a safe altitude.



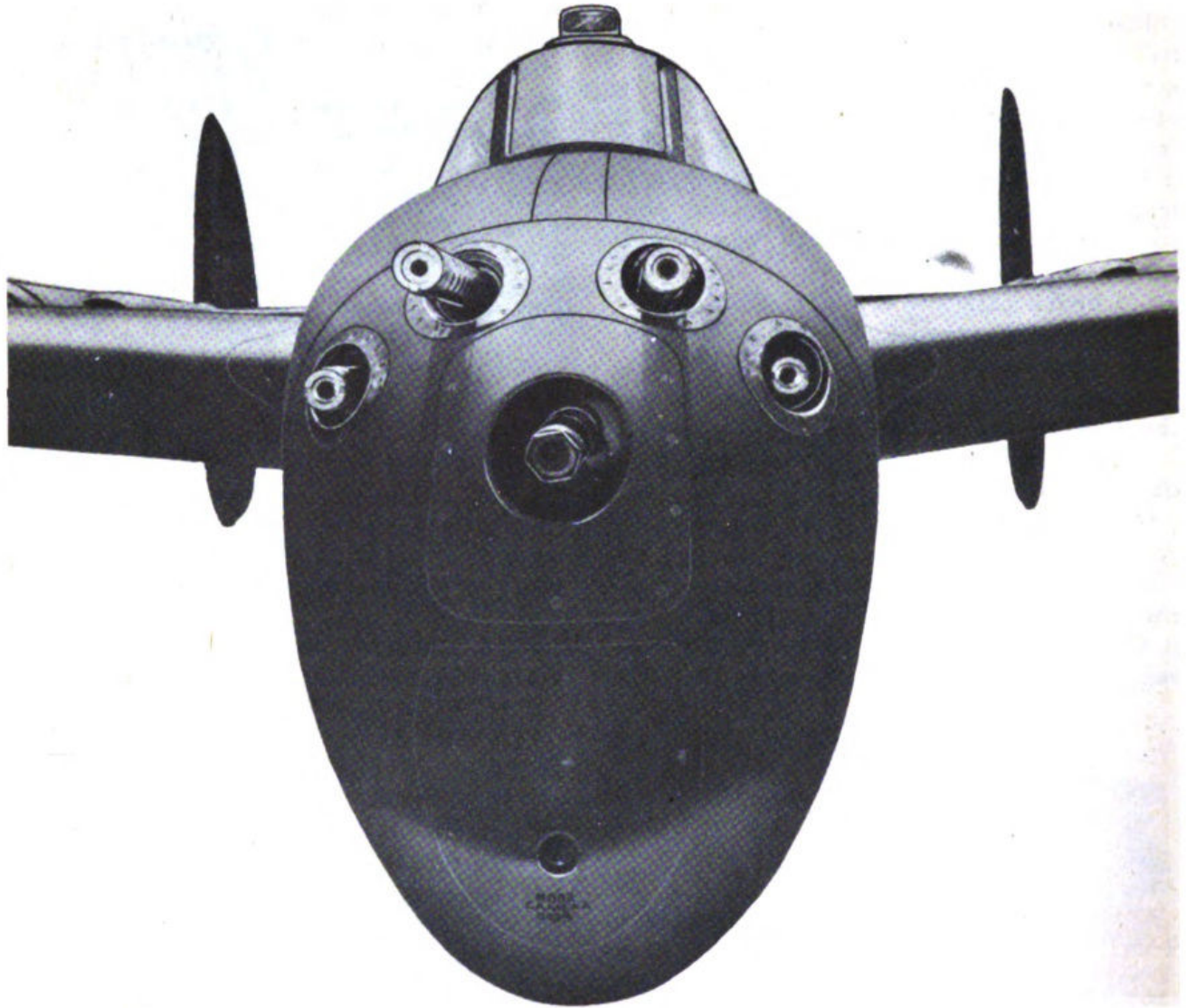

## ARMAMENT

You have four .50-cal. machine guns and one 20-mm. cannon. Three hundred to 500 rounds are carried for each machine gun and up to 150 rounds for the cannon.

To fire the guns, you press trigger buttons on the right side of the control wheel. You fire

the 4 machine guns when you press the trigger on the rear of the wheel with your index finger. You fire the cannon by pressing the trigger on the front or top of the wheel with your thumb. A small motion picture camera is synchronized with the guns.

### To Fire the Machine Guns and Cannon

1. Set camera-combat switch to COMBAT.
2. Squeeze the machine gun or cannon trigger as desired.

In later P-38 series, the cannon is fired at the same time as the machine guns. Both operate off the machine gun trigger button. The former cannon trigger button is used to release drop tanks and bombs and to fire rockets.

### Rockets

The development of high velocity aircraft rockets has greatly increased the destructive capacity of the P-38. Self-propelling, the missiles have no recoil and consequently are launched without danger of damage to the airplane's structure.

Later P-38 series have "Christmas Tree" type rocket racks under each outer wing panel. Each rack carries five 5-inch rockets supported by

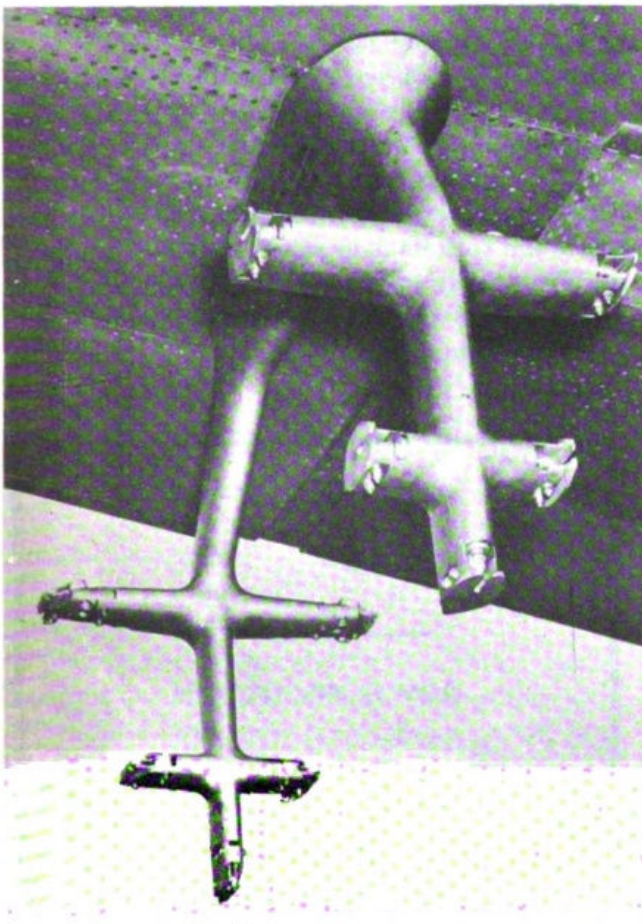

RESTRICTED

two attachments at nose and tail. The forward attachment contains an arming solenoid and supports the rocket by means of a forward-opening slot which engages a lug on the rocket. A safety-wired latch on the aft attachment restrains the rocket from slipping forward and falling off. When the rocket is fired, its forward thrust shears the safety wire, allowing it to shoot forward from the attachments.

### Operation

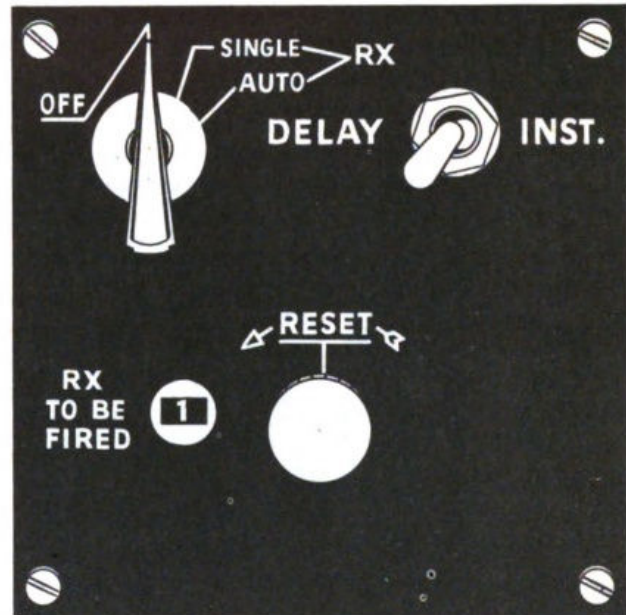

A rocket release control box on the left window sill has a rocket selector switch, an arming switch, and a reset knob. The selector switch positions, AUTO and SINGLE, determine how the rockets are to be fired. Set to AUTO, the rockets fire automatically at one tenth second intervals. Set to SINGLE, a pair of rockets are fired simultaneously; one from each rack.

**Note:** The normal combat installation is set to fire the rockets in pairs. Practice installations are arranged to fire the rockets one at a time.

The arming switch energizes solenoids in each rocket support permitting you to arm the rockets for either DELAYED or INSTANTANEOUS action. There is no SAFE position.

The reset knob can be set to fire as many rockets up to ten as desired. With the selector

**RESTRICTED**

switch in AUTOMATIC, all rockets below the setting chosen on the reset knob can be retained. That is, numbers 1 and 2 won't fire if the reset knob is set at 3. On SINGLE firing, the reset knob automatically moves to the next position as each pair of rockets is fired.

The rockets are launched by igniting the propellant charge in the body of the rocket. The ignition of this charge is controlled by the trigger button on the control wheel; the same trigger which releases the bombs. A bomb-rocket selector switch on the control column switch box must be forward in the ROCKET position before the rockets can be fired.

The procedure for firing rockets is as follows:

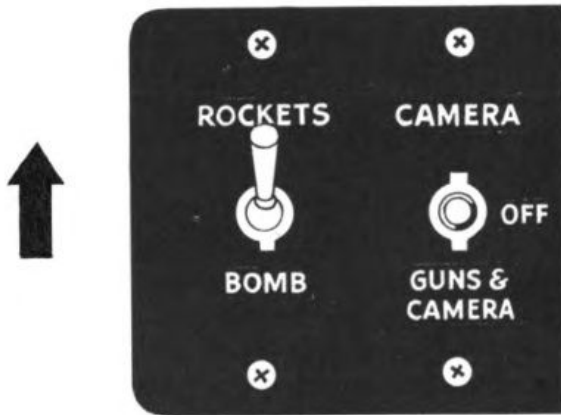

1. Place bomb-rocket switch in ROCKET position:

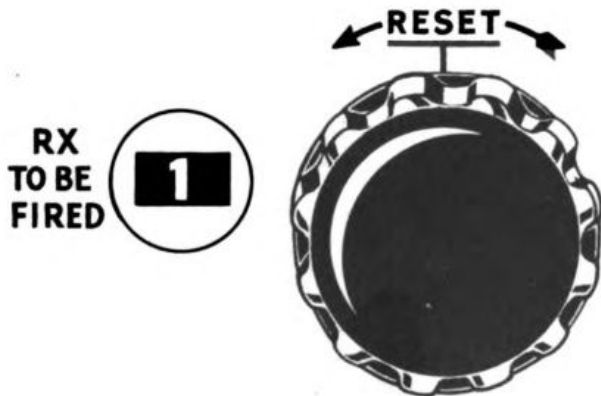

2. Turn reset knob to 1.

3. Place arming switch to DELAY or INSTANTANEOUS, as desired.

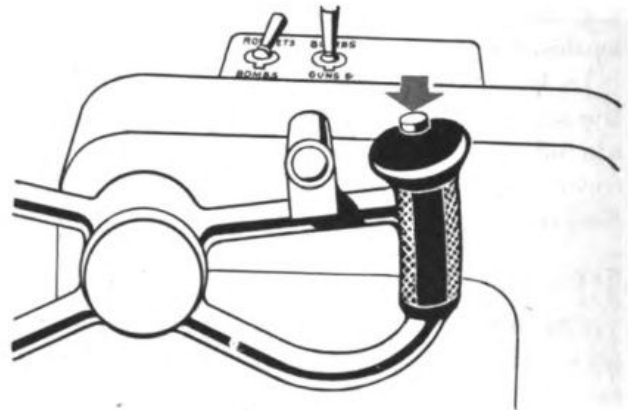

4. To fire the rockets in pairs, place rocket selector switch to SINGLE and press the trigger button, once for each pair of rockets.

5. To fire the rockets in train, place rocket selector switch to AUTO and hold the trigger button down. All ten rockets will be fired in about one second.

Rockets cannot be jettisoned or released in a safe condition like bombs. The base fuze will always detonate the rocket after impact. Therefore, if an emergency situation (an anticipated belly landing) makes it desirable for you to get rid of the rockets, use good judgment in doing so. Fire them into types of terrain, or into water, where the resultant explosion will not endanger human lives.

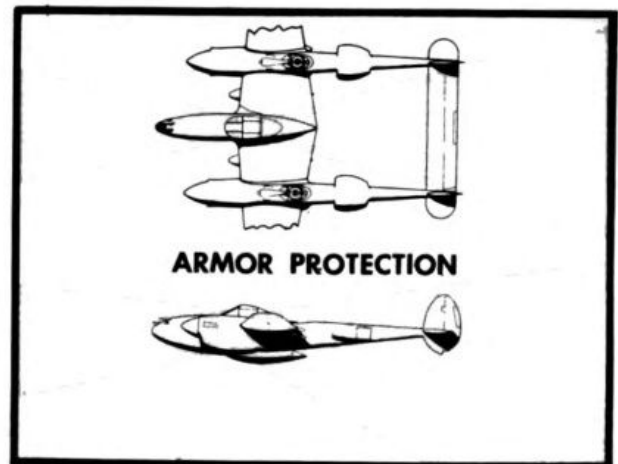

### The Optical Gunsight

Turn the airplane master switch and the gunsight rheostat ON. Adjust the brilliance of the reflection as desired.

Some sights have a sunshade. The sunshade is kept in a box over the fuel cocks. You can install it on top of the sight reflector when necessary.

### The Gun Camera

The camera operates automatically when the cannon and machine guns are fired. If you want to use only the camera without firing the guns, set the camera-combat switch to CAM-

ERA and squeeze trigger button. The camera is in the nose and slightly below the guns. The camera on the P-38L and late P-38J series is under the left wing in the drop tank shackle-housing.

### Gun Heat

Armament and camera compartment heat is supplied by an intensifier tube connected to the left engine exhaust. The control is on the left windshield support on early airplanes. On later airplanes the left engine heat has been diverted to the cockpit and the armament is electrically heated. Electric gun heaters are turned on by a switch on the main switch box.

## CAMERA EQUIPMENT OF THE F-5

The photo-reconnaissance version of the P-38 Lightning, known as the F-5, has no armament. Three types of cameras used in six different arrangements replace all the guns.

One camera, used for mapping, can photograph an area 8 miles by 8 miles from an altitude of 30,000 feet. One film magazine takes about 180 photographs, each 9" x 9" in size. Every photograph overlaps the previous one, mapping a continuous strip of territory 8 miles wide and 540 miles long. The usual photographic "strip" is seldom made over 20 miles long because most targets are single pin points which need no more than a pair of overlapping photographs. These pairs are called "stereopairs" and are studied by trained photo interpreters who are able to measure the relative height, length and width of objects in the photographs.

For detailed interpretation two other types of cameras are used. They take a photograph from 30,000 feet which covers an area as small as a mile and a half wide. From these photographs, interpreters are able to count railroad ties or

identify aircraft even when partially camouflaged. These cameras are used when extreme detail is needed as in locating gun positions and radar installations when only the general position of the targets is known.

A tri-metrogon arrangement uses three cameras which photograph the area from horizon to horizon. These are plotted and used to make maps. One F-5 can map a strip of territory 20 miles wide from 20,000 feet or 30 miles wide from 30,000 feet. By a series of parallel flight paths compilation units are able to make the photographs into accurate maps.

The cameras operate electrically and are remotely controlled by a series of switches in the cockpit. Blinker lights indicate when the cameras are operating. Later F-5 series have a warning light which flashes a few seconds before an exposure is going to be made. This allows you to bank the airplane to look around and then level your wings in time to make an exposure. Photographs can be taken automatically by switching on an intervalometer set for any given interval between exposures.

# LIGHTING EQUIPMENT

## Landing Light

### P-38 Series Through P-38J-15

A retractable landing light is under the left wing. You control it by a 3-position toggle switch on the main switch box. Some P-38 series have two landing lights.

With the landing light switch in the ON position, the light extends and turns on. Place the switch in the RETRACT position to retract the light and turn it off. Leave the landing light switch in the OFF position when not in use.

Extend the landing light at an airspeed of not more than 140 mph.

### Aileron Nibble

When the landing light is extended, it disturbs the airflow over the aileron. This causes an aileron nibble which you feel in the control column. The vibration increases with an increase of airspeed. Don't be alarmed. There is no change in flight characteristics. To stop the vibration, retract the light or reduce speed.

### P-38J-20 Through P-38L-5

The landing light is in the leading edge of the left wing and is turned on or off by a 2-position toggle switch.

## Recognition Lights

Three recognition lights, red, green, and amber, are on the underside of the gondola. On some airplanes a white recognition light is behind the pilot's compartment on the radio equipment. These lights are used as an aid in night formation flying, for signals, and, in combat, for identification.

The four recognition lights are controlled by switches on a control box on the righthand side of the cockpit. The control box is labeled LITE. The switches have 3 positions: OFF, STEADY, and KEY. To turn the lights on, place the switches in the STEADY position. When the switches are in the KEY position, you must press the button on the top of the control box to turn the lights on. Use the KEY position for code or flash signaling.

Do not operate the colored recognition lights for more than 10 seconds on the ground. The heat of the lights will burn through the plastic lenses.

## Position Lights

You control them by switches on the main switch box. BRIGHT, DIM, and OFF positions are provided.

## Cockpit Lights

You control them by a rheostat on the main switch box and a switch on the lights themselves.

## Fluorescent Instrument Lights

They are mounted behind the control column and turned on by a rheostat on the main switch box. Regulate the light intensity by twisting the ends of the lighting unit.

## Spotlight

It is normally on the left windshield support. An alternate position is provided over the fuel tank selector valves. The spotlight switch is on the light, and you can focus the beam by sliding the screw head forward and aft in its slot.

# RETRACTABLE LADDER

The P-38 has a retractable ladder on the rear of the gondola. To lower the ladder:

1. Push the uplock release.
2. Raise the handle to a vertical position.
3. Force the handle down until the ladder locks in the down position.

## To Retract the Ladder

1. Push the downlock release.
2. Pull the handle straight up until the ladder stows in place.
3. Swing the handle forward until it is flush with the gondola contour and press firmly into place.

Always use the retractable ladder to get up on the wing. On later airplanes, a flush hinged handhold is built into the left side of the fuselage.

# SECTION 3 Checks and Flight

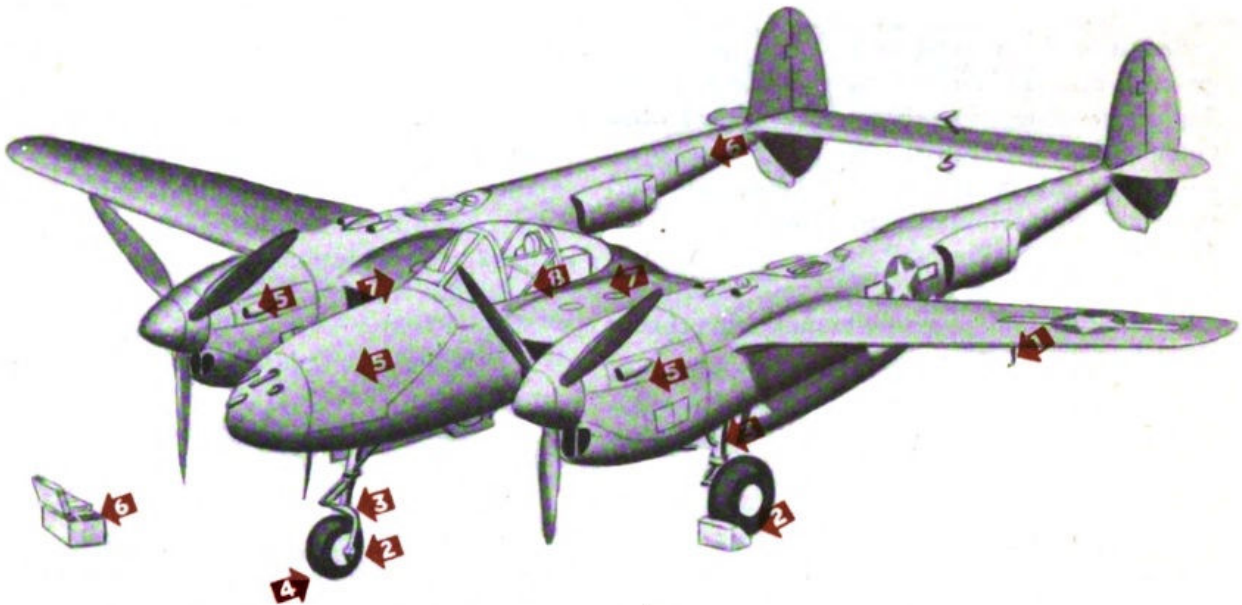

## VISUAL INSPECTION CHECK

Make a complete visual inspection of the airplane.

Try to be out to your airplane at least a half-hour before scheduled takeoff time. This enables you to give the airplane a thorough check and discuss with your crew chief what repairs or changes have been made.

### Check the following

1. Pitot cover removed.
2. Wheels blocked and tires properly inflated.
3. Oleo struts—main wheels extended 2½ to 4 inches. Nosewheel extended 4 to 6 inches.
4. Direction of nosewheel.
5. Cowling fasteners secure.
6. Obstructions close to airplane; tool kits, other aircraft, etc.

**Tip:** Inspect the baggage compartment in the right boom before each flight. Too much weight in the baggage compartment can cause a tail-heavy condition and put your plane out of trim.

**Note:** The P-38 with full complement of guns, ammunition, and fuel (including drop tanks or

bombs) has a center of gravity within the permissible range.

7. Fuel tanks full and caps secure.

To get up on the wing, always use the retractable ladder on the rear of the gondola.

8. Check clearance between dive fillets and windows. Maximum allowable is 3/16 inch. If a plastic seal strip is on the lower part of the window, the dive fillet is flush with the strip.

---

**Tip:** The weight of a few men on the horizontal stabilizer will lift the nose-wheel off the ground and straighten it.





## PREFLIGHT CHECK

Spend as much time as you can with your ground crew. Learn how they perform a preflight inspection, and become confident that you can do it yourself. There may be occasions when you will land at a strange base and find there are no mechanics who know how to preflight your P-38. You will have to perform the preflight before you can take off. Ask your crew chief to show you how to make this check:

1. Bleed the turbo-supercharger balance lines to insure proper performance of the superchargers. The petcocks for this operation are in the main wheel wells. Screw petcock in and allow water to drain. Then screw it out again and re-safety.

2. Drain the fuel strainers, which are under the center portion of the gondola. Remove the recognition light panel and drain about a pint of gasoline from the four petcocks. Then close and re-safety.

3. Check the supercharger wastegate for

freedom of movement. It's behind the turbo-wheel.

4. Examine turbo wheel for elongated buckets and cracks.

5. Check to be sure you have sufficient fuel, oil, coolant, and hydraulic fluid. The oil tanks are outboard of the engine nacelles near the leading edge of the wing. Fill to approximately 4 inches from the top. The hydraulic fluid reservoir is on top of the gondola and behind the canopy. Fill to the strainer and turn purolator filter two revolutions.

6. Pull the propellers through at least 9 blades.

7. Make a complete **visual check** of the airplane.

8. Start the left engine and check the hydraulic pump operation by lowering and raising the flaps. Note the time the operation takes.

9. Start the right engine and check right hydraulic pump by lowering and raising flaps. This operation with both engines running requires approximately half the time it takes with one engine.

10. Test feather switches. Do not allow the propellers to feather completely.

11. Test all warning lights.

---

## SPECIFICATIONS

---

### FUEL

Specification AN-VV-F-781 (Amendment No. 5 or better), AN-F-28, or AN-F-29 (Grade 100 Fuel). AN-F-26 (Grade 91 Fuel; refer to T. O. No. 02-1-38 and 02-5A-66A).

### ENGINE OIL

Specification AN-VV-O-446, Grade 1120. For cold weather operation, Grade 1100A.

### SUPERCHARGER OIL

Specification AN-VV-O-446, Grade 1065.

### COOLANT

Specification AN-E-2 (Ethylene Glycol—inhibited with NaMBT).

### HYDRAULIC FLUID

Specification AN-VV-O-366.

## COCKPIT CHECK

1. Check the Form 1A. Discuss it thoroughly with your crew chief.

2. Secure parachute, shoulder harness, and safety belt. Adjust the seat by lifting the small lever on the right side of the seat. After you have adjusted the seat and released the lever, check to make sure the seat is firmly locked in the new position.

**Important:** Don't wear the shoulder harness if you can't reach all the controls when it is on and unlocked, except in preparation for an emergency landing.



**Notice to pilots with short legs:** Use cushions to place you well forward in the cockpit. This will give you full rudder control.

3. Connect head set and adjust throat mike; look to see that mike jack is in place.

4. Close the canopy and make sure it is locked.

Check to be sure that both catches of the canopy overlap and that the rear pins are securely in position.

5. Check for free movement of the flight controls to the extremities of their operating range.

Adjust rudder pedals for correct leg length by means of the spring-loaded levers on the pedals.

6. See that control lock is in place.

7. Adjust trim tabs to proper setting—rudder and aileron neutral, elevator 3° back.

8. Fuel selectors to RESERVE. (Set fuel selectors by click and feel.)

9. Crossfeed switch OFF. (Crossfeed switch is replaced by cross suction position of the tank selector valves on later airplanes.)

RESTRICTED

10. Fuel booster pumps OFF.  
11. Turn bomb selector switches ON and arming switch to SAFE.

This is a must when carrying drop tanks or bombs so that you can get rid of them quickly if an engine fails on takeoff.

12. Crack throttles.

13. Propeller control governors full forward in takeoff position.

14. Propeller selector switches AUTO-MATIC.

15. Mixture controls in IDLE CUT-OFF.

16. Carburetor air filter lever as required.

17. Propeller circuit breakers ON.

18. Propeller feathering switches in NORMAL.

19. Set clock and altimeter.

20. Oxygen pressure 400 to 450 psi.

21. Gun switch OFF.

22. Wing flaps up and flap control lever in CLOSED position.

23. Aileron boost ON.

24. Radio OFF.

25. Test auxiliary hand hydraulic pump.

### ADDITIONAL CHECK FOR NIGHT FLYING

#### *Test Operation of:*

1. Landing lights (not more than 5 seconds with engines not running).

2. Recognition lights (not more than 10 seconds on the ground).

3. Cockpit lights.

4. Fluorescent lights.

5. Position lights.

6. Spotlight.

## STARTING ENGINES

There are no engine fire extinguishers in the P-38. Reduce the possibility of fire by adhering strictly to the following information concerning the use of the mixture controls.

### *Important*

If a fire occurs while you're starting an engine, immediately return the mixture control to IDLE CUT-OFF and advance the throttle. Turn the fuel selector valve and booster pump OFF. If the fire continues, keep the engine turning over with the engaging switch.

If your battery power is not sufficient for starting, use the inertia hand crank or an external energizer.

Be sure you are ready to go before starting the engines, for they overheat rapidly. Always start the left engine first.

1. Battery and ignition switches ON.

Use a battery cart if available. If you do use one, do not turn battery switch on until after you've started the engines.

2. Turn generator switch(es) ON.
3. Turn booster pump ON.
4. Prime the engines. Cold engines require more prime than warm engines.
5. ENERGIZE engine.
6. ENGAGE the starter. Hold it until the engine definitely fires.
7. When the engine definitely fires, advance the mixture control to AUTO RICH.

**Important:** If the engine dies, immediately return the mixture control to IDLE CUT-OFF.

8. Idle the engine at 1000 rpm—above vibration and fouling point.

Now, start the right engine in the same manner.

**Stop the engines if the oil pressure does not register within 30 seconds.**

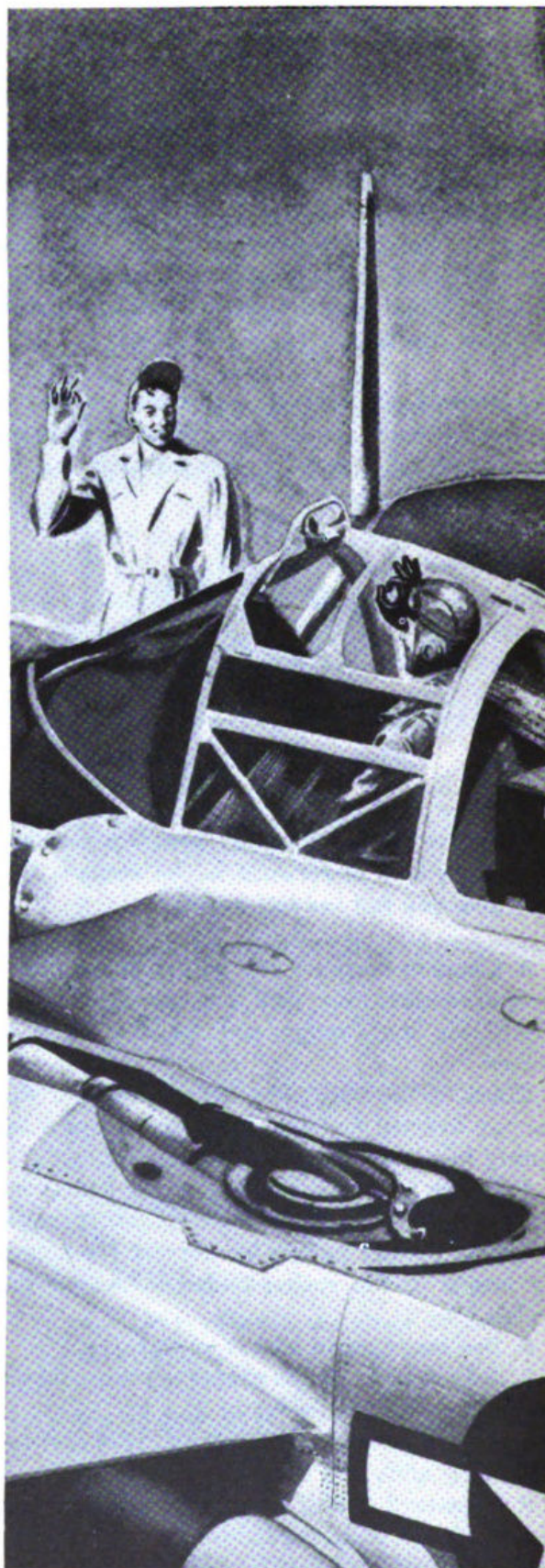

**After Both Engines Are Running Smoothly:**

1. Turn the radio ON and tune to proper frequency.
2. Inverter switch (or compass switch on switch box) ON.
3. Coolant and oil shutters in AUTO-MATIC (OFF).
4. Intercooler shutters OPEN (if installed).
5. Check gunsight light.
6. Push button to test turbo or fuel warning light (if installed).
7. Check fuel quantity gages.
8. Uncage gyro instruments.

**Engine Warm-up**

The engine warm-up is comparable to the few turns you make around the track before you really start to run.

Don't exceed 1400 rpm until minimum temperatures and pressures have been reached—oil temperature at least 40°C, and oil pressure between the red lines (approximately 75 psi).

Oil pressure may be high if the engines are cold and low if the engines are hot. Don't leave the line until the oil pressure is within the red line limits.

Other temperature and pressures are:

**Coolant temperature—at least 85°C.**

**Fuel pressure—between 16 and 18 psi.**

**Hydraulic pressure—between 1100 and 1400 psi.**

After the above minimum temperatures and pressures are reached, place the coolant and oil shutters in the full open position. This helps to prevent the engines from over-heating.

**CHECK THAT THE MIXTURE CONTROLS ARE IN AUTO RICH. THE AUTO LEAN MIXTURE POSITION IS NEVER USED FOR ANY GROUND OPERATION.**

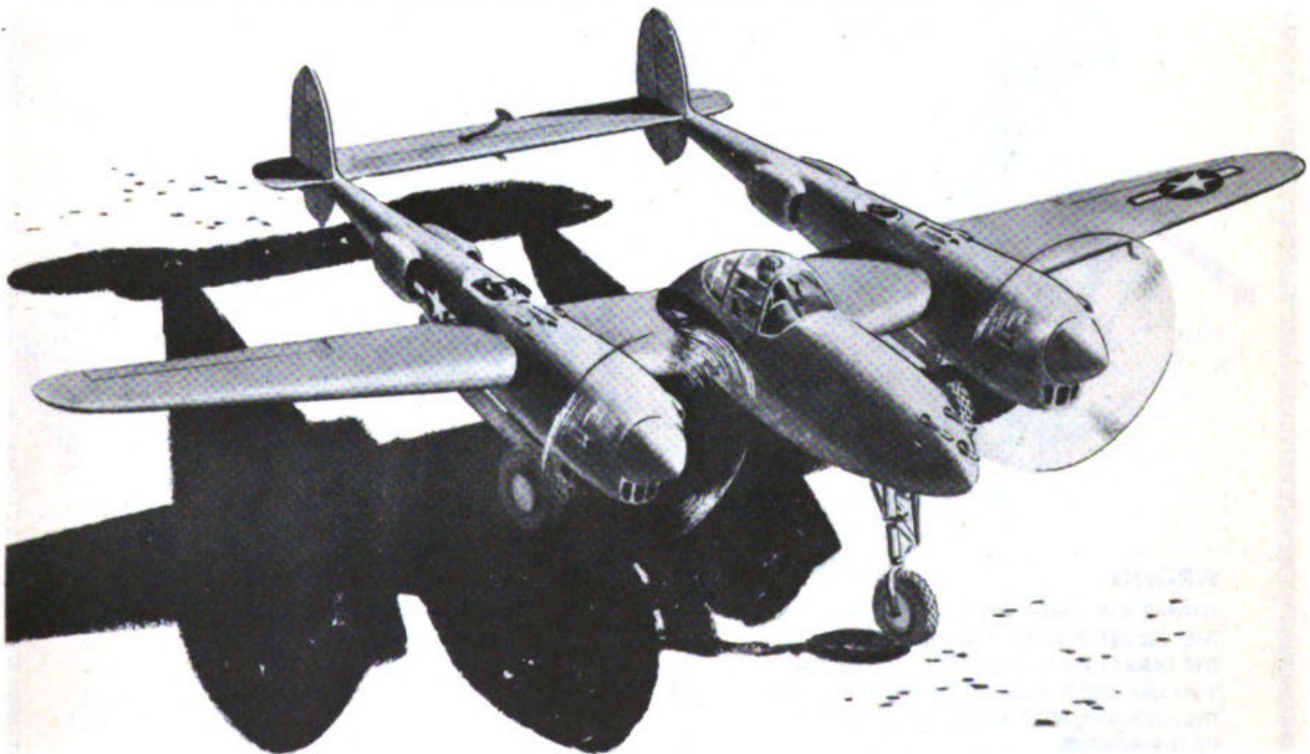

*Now You Are Ready to Taxi*

## TAXI TECHNIQUE

The airplane taxis easily. There is no danger of a nose-over or a groundloop if you find you must turn sharply or apply full brakes. You have unobstructed vision because the airplane is in a level attitude and you are surrounded by plexiglas.

### *Remember*

**THERE IS NO EXCUSE FOR A TAXI ACCIDENT**

## TAXI PROCEDURE

Be sure your crew chief and all other members of the ground crew are clear of the airplane before you start to taxi. Your job is to kill the enemy, not your friends.

1. Establish proper radio contact before leaving the line.

(Have forward motion before turning.)

2. Look out both sides and in front.

3. Taxi slowly.

(Always keep your brakes pumped up.)

4. Brake intermittently, not continuously. Don't ride the brakes.

5. Turn slow and wide. A sharp turn causes stress on the nosewheel.

6. Keep your hand on the throttles and your feet on the rudder pedals at all times.

7. Stay on the taxi strip. The P-38 is a heavy airplane and will bog down in the soft earth—an easy way to snap a nosewheel.

8. Stop at a 45° angle to the runway so that you have good rear and forward vision.

9. Be sure it is clear behind you before you run up the engines. Be both a pilot and a gentleman.

10. Test brakes in taxiing out. If either or both brakes are weak, return to the line.

## HOW TO HOLD AND USE TOE BRAKES

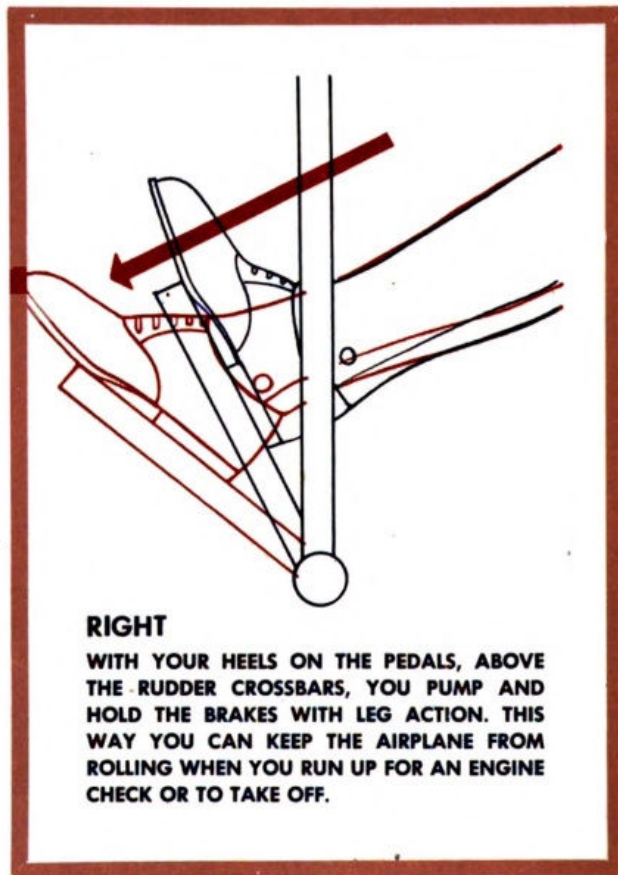
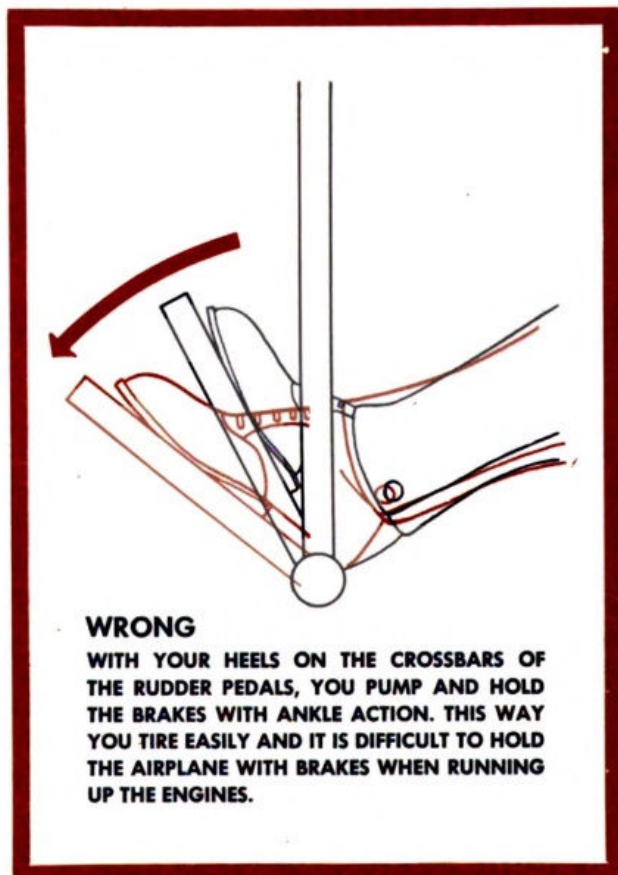

## BEFORE TAKEOFF

This is the time when you can find out what you want to know about your airplane. Don't be in a hurry to take off. A little extra time before takeoff can save you a lot of trouble after you are in the air.

Here is the check you make before takeoff. Follow it closely!

1. Safety belt locked. Shoulder harness on and unlocked.
2. Canopy locked and side windows closed with ratchets ON.
3. Rudder and aileron tabs at 0.
4. Elevator trim tab 0° to 3° back (this relieves pressure on control column).

### Tip

The windows slide down if ratchets are not ON. If a side window is even partially down on takeoff it causes the tail section to buffet.

5. Fuel selectors on RESERVE.
6. Electric fuel booster pumps ON.
7. Drop tank selector switches ON and arming switch SAFE.
8. Propeller governor controls full forward.
9. Propeller selector switches AUTOMATIC.
10. Tighten friction control.
11. Mixture control AUTO RICH.
12. Set gyro flight instruments. Check gage for approximately 4" of vacuum.
13. Generator switch(es) ON.
14. Oil and coolant shutters AUTOMATIC.
15. Intercooler flaps OPEN. (If installed.)
16. Dive flaps UP.
17. Wing flaps up and control handle in CLOSED.
18. Aileron boost ON. Turn control wheel to full travel in both directions. Do this a couple of times to be sure the aileron boost control is working properly.

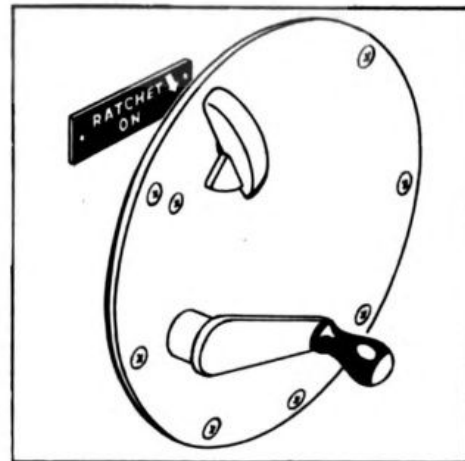
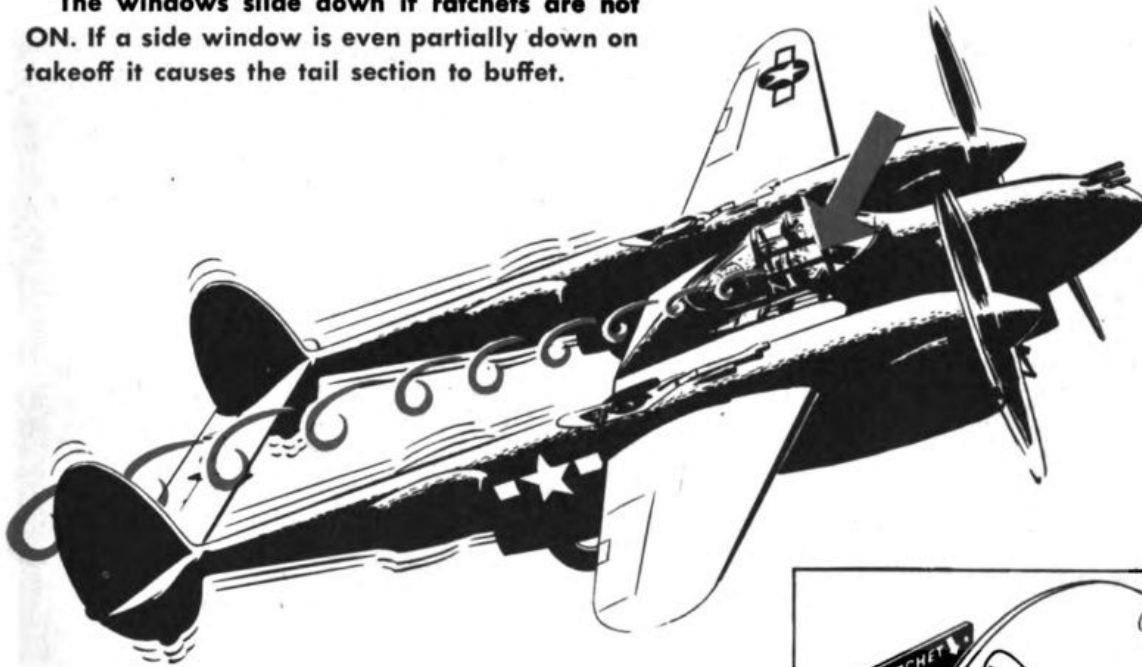

RESTRICTED

69

## RESTRICTED

Now you are ready to check your engines:

It is far better to know what condition the engines are in before takeoff than to wait until you are off the ground. Remember, you're the fellow who is going to fly this airplane. Be confident that it is operating properly.

Check the direction of the nosewheel by looking at the polished area on the inside of the engine nacelles. See that it is straight before you run up the engines.

When you are ready for the run-up check, apply the power smoothly.

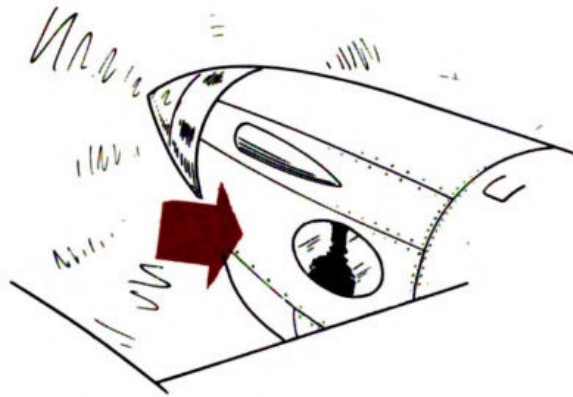

CHECK DIRECTION OF NOSEWHEEL IN POLISHED AREA ON NACELLES

## RUN-UP CHECK

Pump the brakes so you can hold the airplane and then check both engines, one at a time, in the following manner:

1. Check the magnetos at 2300 rpm. If there is a drop of more than 100 rpm, return to the line.

Caution: Check the magnetos with the propeller switches in **AUTOMATIC** and not in the selective **FIXED PITCH**. This eliminates the danger of forgetting to return the switches to **AUTOMATIC**. A takeoff with propellers in selective **FIXED PITCH** causes them to overspeed.

2. Propeller governors in full forward takeoff position.
3. At 2300 rpm, pull the governor back until you get a reduction of 200 rpm.
4. Return the governor to the full-forward takeoff position, noting that it again attains 2300 rpm. If it does, the propeller is operating properly and ready for flight.
5. Check voltmeter for 28 volts and ammeter charging below 50 amps.

**MAINTAIN AT LEAST 1200 RPM TO KEEP THE SPARK PLUGS FROM FOULING**

70

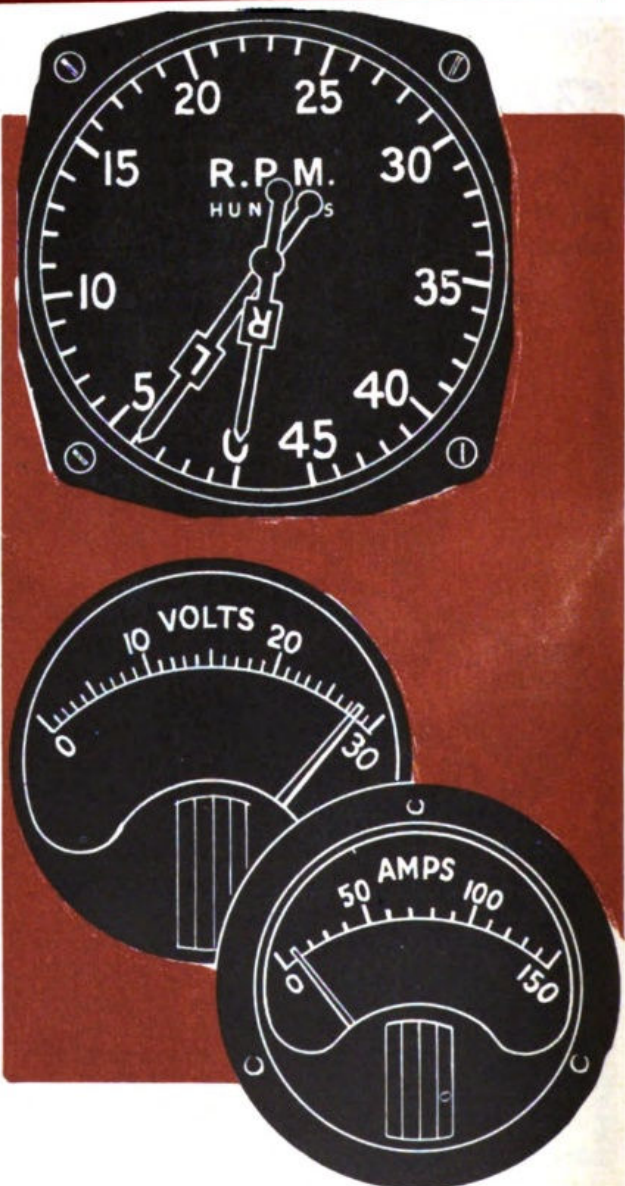

RESTRICTED

# TAKEOFF

Roll the airplane a few feet down the runway so that the nosewheel will be in line when you apply power. Check its direction by means of the polished area on the inside of the engine nacelles.

No-flap takeoffs are preferred because you reach minimum single engine performance airspeed more rapidly this way than when you use flaps.

For maximum performance takeoffs, hold the airplane with brakes at the end of the runway until allowable takeoff manifold pressure and rpm have been reached. Then release the brakes. This way, the superchargers are in operation before you start your roll. Also, you have ample time to stop within the limits of the field in case of an emergency.

The tricycle landing gear gives the airplane a level flight attitude on the ground. During your roll down the runway, the wings offer a negative angle of attack and there is no tendency for the airplane to take off by itself. You will notice that there is no feeling of lightness as you reach takeoff speed. The airplane literally has to be lifted off the ground. At 80 mph ease the wheel back steadily and firmly. At 100 mph the airplane becomes airborne.

When you are certain you are airborne, retract the landing gear. The landing gear offers considerable drag when it is down. With the gear up, you quickly reach the minimum single engine airspeed of 130 mph.

Keep your hand on the throttles so that you can meet any emergency instantly.

## P-38 TAKEOFFS

THE FOLLOWING FIGURES ARE APPROXIMATE AND VARY WITH WEIGHT AND WIND CONDITIONS. BUT IN ALL INSTANCES, TAKEOFFS WITH RECOMMENDED MANIFOLD PRESSURE AND RPM (1 BELOW) REDUCES THE GROUND RUN AND THE CRITICAL TIME IMMEDIATELY AFTER BECOMING AIRBORNE UNTIL YOU REACH SAFE SINGLE ENGINE AIRSPEED.

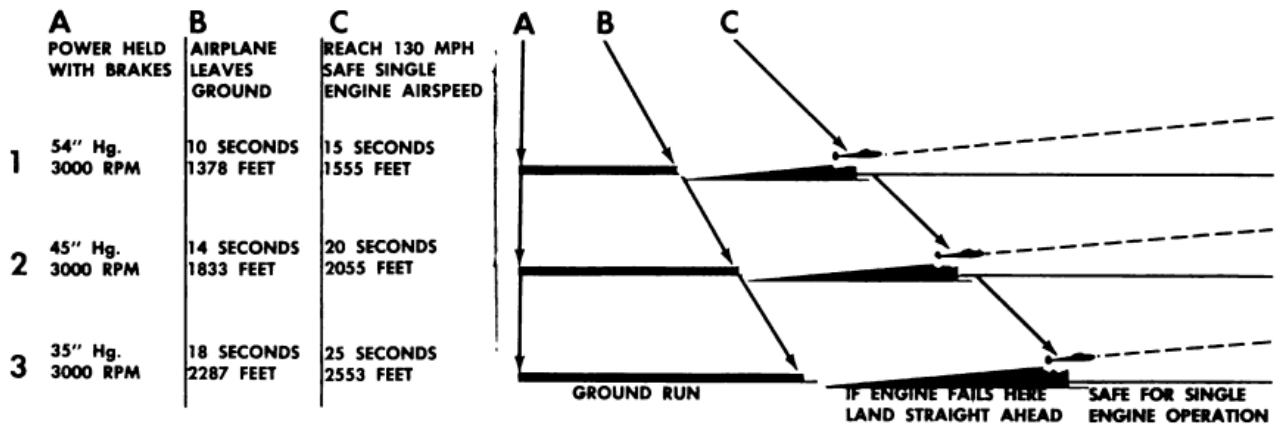

USE UP TO 1/2 FLAPS FOR SHORT FIELD TAKE OFFS, CLEARING OBSTACLES, AND WHEN CARRYING DROP TANKS

## TAKEOFF PROCEDURE

1. Pump brakes and hold.
  2. Open the throttles to prescribed takeoff manifold pressure and rpm.
  3. Release brakes.
  4. When you are certain you are airborne retract the landing gear.
- Tip:** After takeoff from a muddy field, brake the wheels before retracting the landing gear. This

prevents mud from being thrown into the wheelwells.

5. Reduce the power to prescribed climbing manifold pressure and rpm after you've reached sufficient airspeed and have cleared all obstacles.

**Note:** If you used flaps, retract them after you have at least 500 feet altitude.

6. Check your temperature readings to be sure you have proper automatic operation.



# OPERATING DATA

GRADE 100 FUEL		
P-38H, P-38J and P-38L V-1710-89 and V-1710-91 engines. V-1710-111 and V-1710-113 engines.	MANIFOLD PRESSURE	RPM
<b>Military Takeoff Power</b>	54"	3000
<b>Normal Rated</b> Maximum recommended for operation with AUTO RICH mixture in level flight and climb.	44"	2600
<b>Maximum Cruise</b> Maximum recommended for operation with AUTO LEAN mixture.	30"	2300

**P38 J & L POWER SETTING CHART**  
USE WITH ANF 28 FUEL MAX C.A.T. 60°C

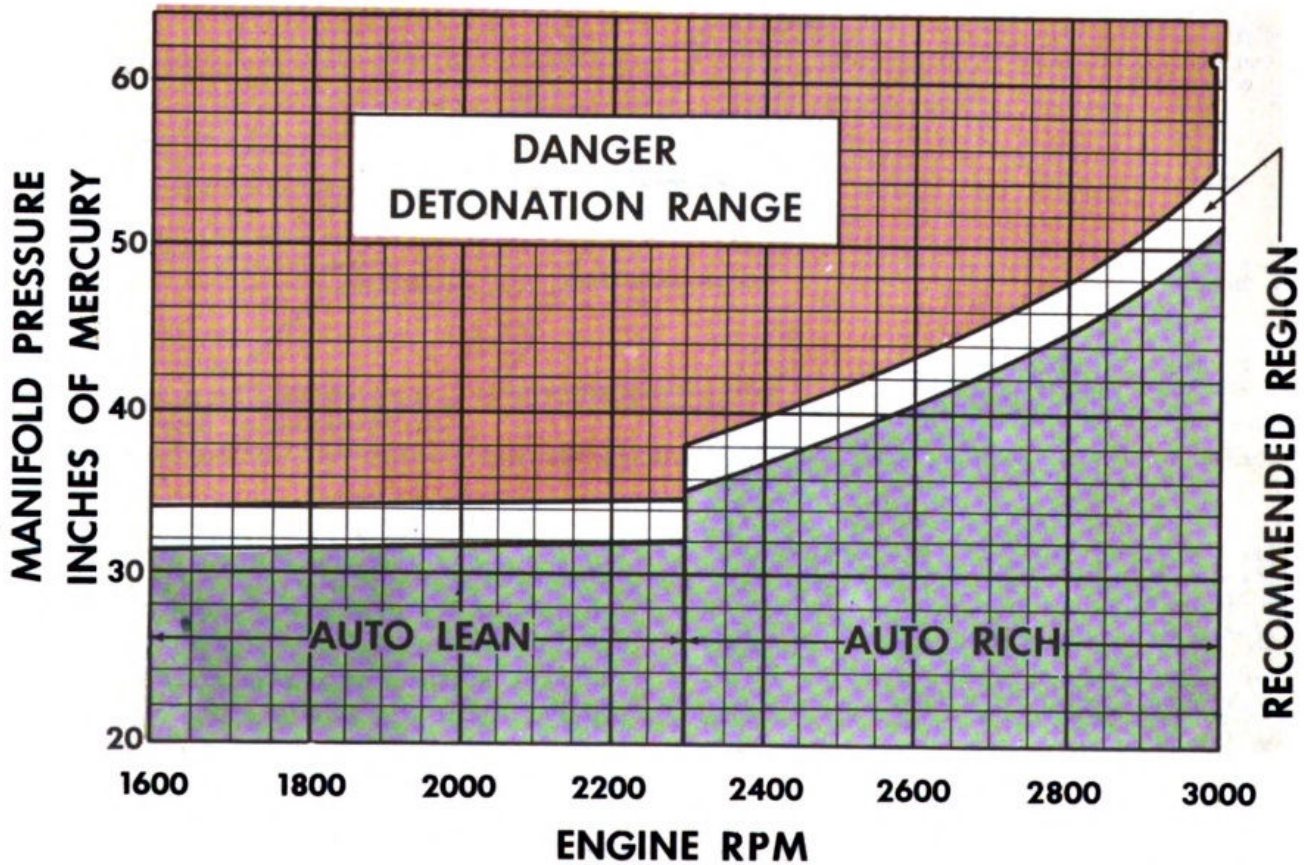

# CLIMB

After takeoff, establish desired climbing manifold and rpm settings.

Make frequent checks on the temperatures and pressures to be sure you have proper automatic operation.

Your most efficient climbing speed is between 155 mph and 175 mph. Try to keep the airspeed at 165 mph IAS.

You need little or no trim for rudder and aileron, but save your strength and relieve that nose heaviness with the elevator trim tab.

After you have established a normal climb, turn the electric fuel booster pumps OFF.

**Important:** If you are going to altitude, you must turn the electric booster pumps on again at approximately 12,000 feet.

# CRUISE

Watch your gasoline supply carefully. Fly for the first 15 minutes on RES (reserve). Time each tank. Don't depend entirely upon the fuel quantity gages.

You will find the airplane trims easily and flies hands off.

Make it a habit frequently to check all the engine instruments for proper reading. After a while, you will be able to read all the instruments at a brief glance.



Learn to keep your head out of the cockpit

# STALLS

In either power-on or power-off stalls with flaps and landing gear up, the airplane mushes straight ahead in a well controlled stall. With flaps and gear down, there is a slight tendency for one wing to drop. Under these conditions, the nose drops slightly and, as the airspeed increases, the wing comes up. There is little tendency to spin or whip off on one wing.

There is a noticeable vibration as you approach the stalling speed. The center section stalls first while the ailerons remain unstalled and effective. With power on there is excellent rudder control.

Practice stalls so that you know the feel of the controls near the stall and the indicated stalling speed of your airplane.

With power off, the P-38 stalls at approximately the following indicated airspeeds at the gross weights noted:

### Flaps and gear up

15,000 lbs.	17,000 lbs.	19,000 lbs.
94 mph	100 mph	105 mph

### Flaps and gear down

15,000 lbs.	17,000 lbs.	19,000 lbs.
69 mph	74 mph	78 mph

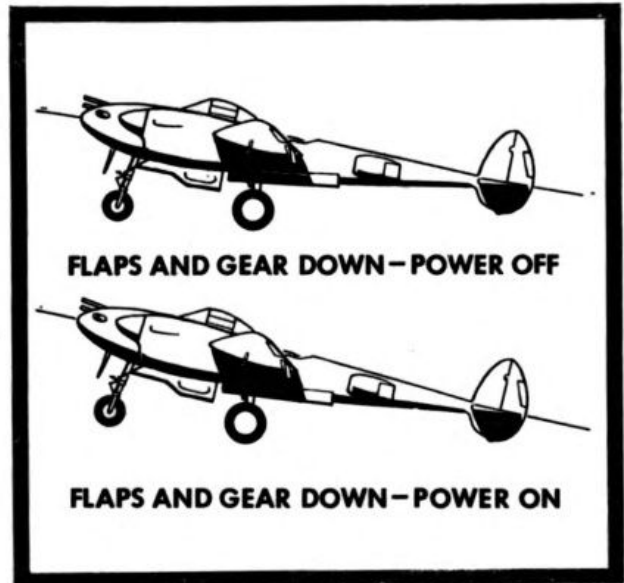

# Flight Restrictions

1. Snap rolls.
2. Continuous inverted flight.
3. Don't exceed 3.5 negative G's. Excessive G's, as in inverted flight, cause the oil to leave the bottom of the crankcase, preventing sufficient lubrication from reaching the bearings.
4. Take extreme care during aerobatic

maneuvers which require a downward recovery (split S). Twelve thousand feet in a P-38 isn't high.

5. Never deliberately spin the P-38 below 15,000 feet above the ground.

6. Don't exceed the IAS at the different altitudes as given on the DIVE LIMITS placard posted in the cockpit.

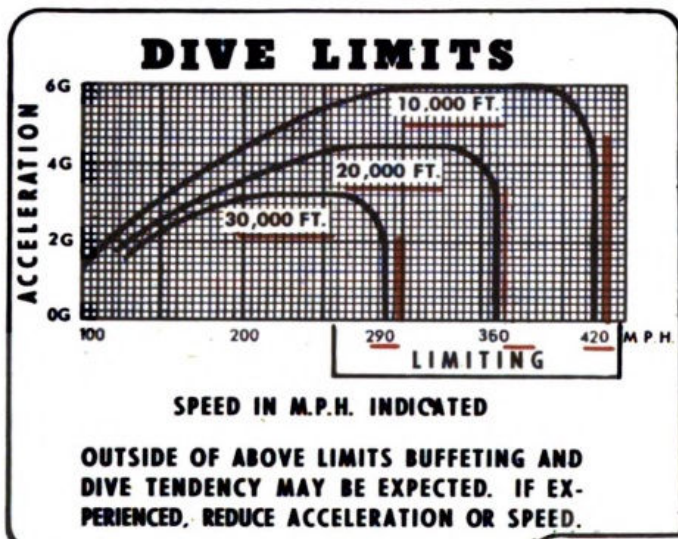

◀ In early P-38 series, this placard is on the left side of the cockpit between the electric drop tank release box and the engine control stand. In later airplanes it is on the horizontal arm of the control column. It is there for your reference.

This has been designed to replace the above placard. The IAS red line at 20,000 feet has been changed and TAS is included to give you an estimate of your actual ground speed. The reason for these changes are shown in the chart on page 76.

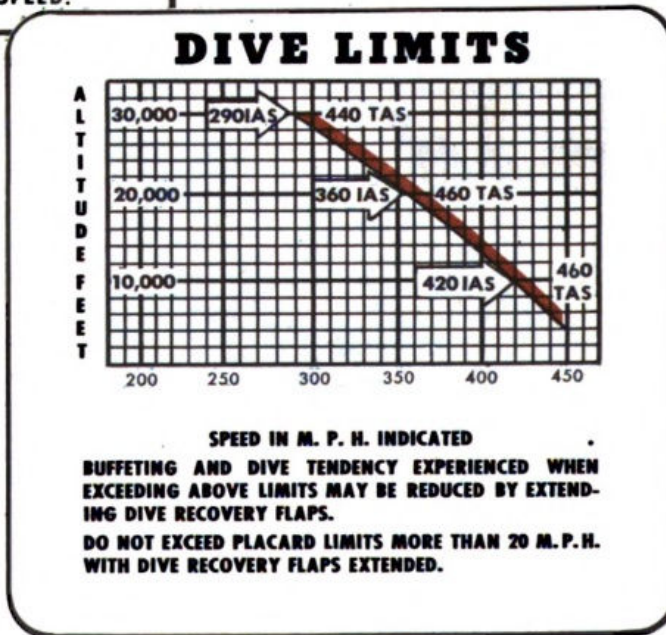

## DIVES



In all high speed aircraft, particularly the P-38, you encounter a serious acceleration problem.

Previously you have flown airplanes that had a comparatively low terminal velocity and did not accelerate above a certain speed.

This is our problem: In high speed dives, the lack of resistance, due to the clean lines of the airplane, causes a tremendous acceleration if gravity is allowed to exert its full influence. As you approach the critical airspeed, the airplane becomes noseheavy and starts to buffet as if you were about to stall. Therefore, it is very foolhardy to point the P-38 straight down for any length of time. Adding to this problem of acceleration is the problem of time required and space necessary to pull out of the dive and regain straight and level flight.

In your flying experience you have become aware of the futility of trying to recover from a stall by holding the stick back. The same situation exists here. In a high speed dive, only a few G's cause the airplane to buffet.

When it is necessary to point down, reduce power and enter the dive at a low airspeed.

*Caution:* USE THE ELEVATOR TAB WITH EXTREME CARE.

TOO MUCH TRIM CAUSES A TAIL-HEAVY CONDITION.

### CAUTION

Manifold pressure must be kept at or above 20" Hg during extended shallow dives in order to prevent the engines from misfiring when you advance the throttles after the pullout from the dive.

### Normal Dive Recovery

If you have allowed yourself to build up excessive airspeed in a dive, follow this recommended procedure for recovery:

1. Pull back the throttles (if you haven't already done so).
2. Apply sufficient back pressure until you feel a slight nibble in the wheel. Any further pressure causes the airplane to buffet and defeats your purpose of trying to pull out.
3. Use only a few degrees of elevator trim tab to help you.

**Relationship of Airspeed and Altitude**

The maximum safe airspeeds for the P-38 at different altitudes are given in the accompanying chart. Notice in the chart that the airspeeds are given in terms of IAS (indicated airspeed) and TAS (true airspeed). Notice also how greatly these two figures differ. At 30,000 feet, for example, 300 mph IAS means you are actually traveling 480 mph TAS. A good rule of thumb to remember in making this airspeed correction is:

**Increase IAS 2% per 1000 feet.** This is the way it works out in the above example: 2% for each 1000 feet in 30,000 feet is 60%; 60% of 300 IAS is 180 mph; add 300 and 180 mph and you have 480 mph TAS.

The red line on the airspeed indicator of the P-38 is placed at 420 mph. That does not mean 420 mph IAS at any altitude. That is simply the speed at which the load on the wings and other structural parts reaches the maximum they are designed to carry.

Notice in the chart that above 10,000 feet the indicated red line is less than 420 mph IAS and continues to decrease with an increase of altitude. At 30,000 feet, your safe maximum IAS is 290 mph.

In other words, the red line is not a fixed figure, but a **variable** figure—variable with altitude. The higher you go, the lower the maximum allowable IAS.

Many pilots fail to realize this great difference between IAS and TAS at high altitudes. Don't be fooled. Study these figures carefully, **Never exceed these airspeeds.**

In the case of high speed fighter planes, a new factor enters the picture which makes diving unsafe at high altitudes long before the usual red line is reached. This new factor is compressibility. It is the reason for the variable red-line speed as given in the chart.

Another rule of thumb in correcting IAS to TAS is: Add 5 mph per 1000 feet to IAS to get TAS.

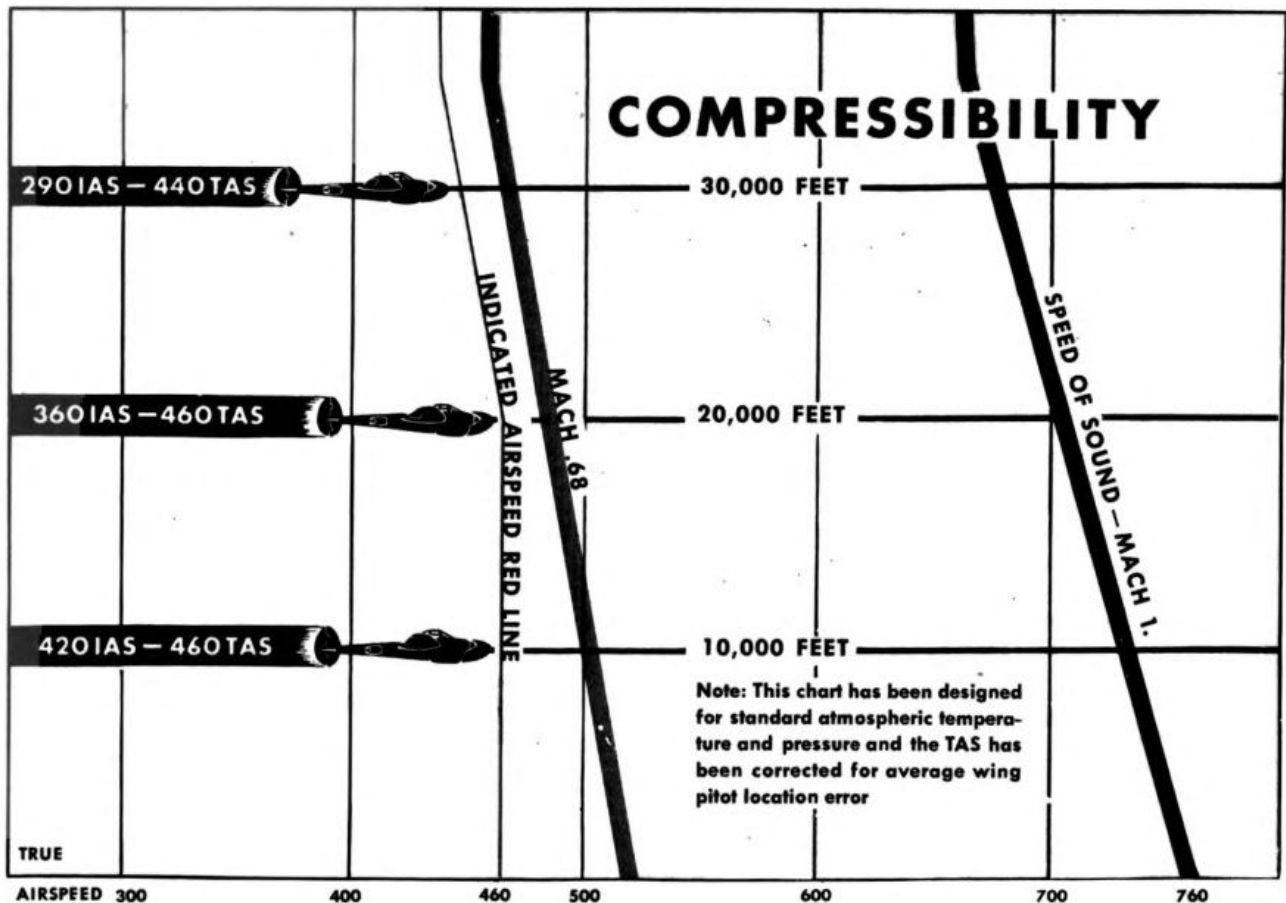

# COMPRESSIBILITY

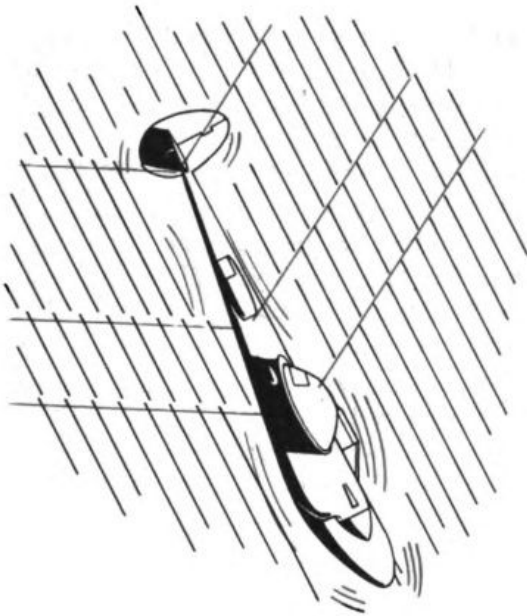

Since extremely high airplane speeds have been developed only in recent years, the phenomenon of compressibility is still pretty much of a mystery. Scientists and engineers know comparatively little about it and dive tests are still being run to prove or disprove the many theories about it. Here we attempt to give you a pilot's explanation about compressibility in a P-38; one that will help you understand this phenomenon and impress upon you the importance of avoiding it.

About all that is known for certain is this. When an airplane approaches the speed of sound, it loses its efficiency. Compression waves or shock waves develop on the wings and other surfaces of the airplane.

Although there is a great deal of disagreement as to what happens when compressibility is reached, and why, there is no question as to the result, so far as the pilot is concerned.

The lift characteristics of the airplane are greatly reduced and the stability, control, and trim are affected.

Each type high speed fighter plane has its own individual compressibility characteristics. In your P-38, the first effect as you approach compressibility is that the airplane becomes

noseheavy. The control wheel moves forward and becomes increasingly difficult to pull back. At this stage, an uncontrollable buffeting and vibrating develops. If the speed of the airplane isn't checked and control regained, it is possible that the terrific vibrations of the shock waves may cause structural failure, or the airplane may crash while still in the compressibility dive.

## Relationship of Compressibility to the Speed of Sound

Under standard temperature and atmospheric conditions, the speed of sound at sea level is 760 mph. An airplane goes into compressibility before actually reaching the speed of sound. This speed varies in different airplanes depending upon the individual design of the airplane.

The speed at which an airplane enters compressibility, in ratio to the speed of sound, is technically known as its **Mach number** (pronounced Mock and named after the man who did considerable research in this field).

One of the most important things to remember about compressibility is that the speed of sound varies with altitude. Note these approximate figures:

At sea level, sound travels 760 mph.

At 35,000 feet, sound travels 670 mph.

**35,000 feet → 670 mph**

**Sea Level → 760 mph**

**THE SPEED OF SOUND DECREASES WITH AN INCREASE OF ALTITUDE**

Therefore, the higher you go, the sooner you reach the speed of sound, and the lower your safe IAS will be.

In a high speed dive from altitude, you get into compressibility before you reach the 420 mph IAS red line on the airspeed indicator.

## COMPRESSIBILITY DIVE

It is possible to come out of compressibility if you don't go too far. This all depends on the circumstances of the dive; the angle, starting altitude, airspeed, and the point at which compressibility was reached.

Then there is this to consider; while in compressibility you have no control over the airplane. Also it is possible to aggravate your situation and make it a lot worse. All that you can do is pull back the throttles (if they aren't already back), hold the stick as steady as possible with some back pressure, and then ride it through until you decelerate enough, at a lower altitude, to reduce your speed below the red line speed given in the chart. This usually means an uncontrolled dive of between 10,000

feet and 15,000 feet, depending upon circumstances.

The exact altitude you drop and the length of time you are in compressibility depends to a great extent upon the angle of dive in which you encountered compressibility.

Only after you have lost enough speed and altitude will you come out of compressibility and regain control of your airplane. At that point, with the airplane again under control, you can **begin** to come out of your dive.

Note that last sentence carefully. You can then **begin** to come out of your dive—that's after losing 10,000 feet to 15,000 feet. If at that point you still have sufficient altitude for a controlled dive recovery, you're okay. If you don't . . . ?

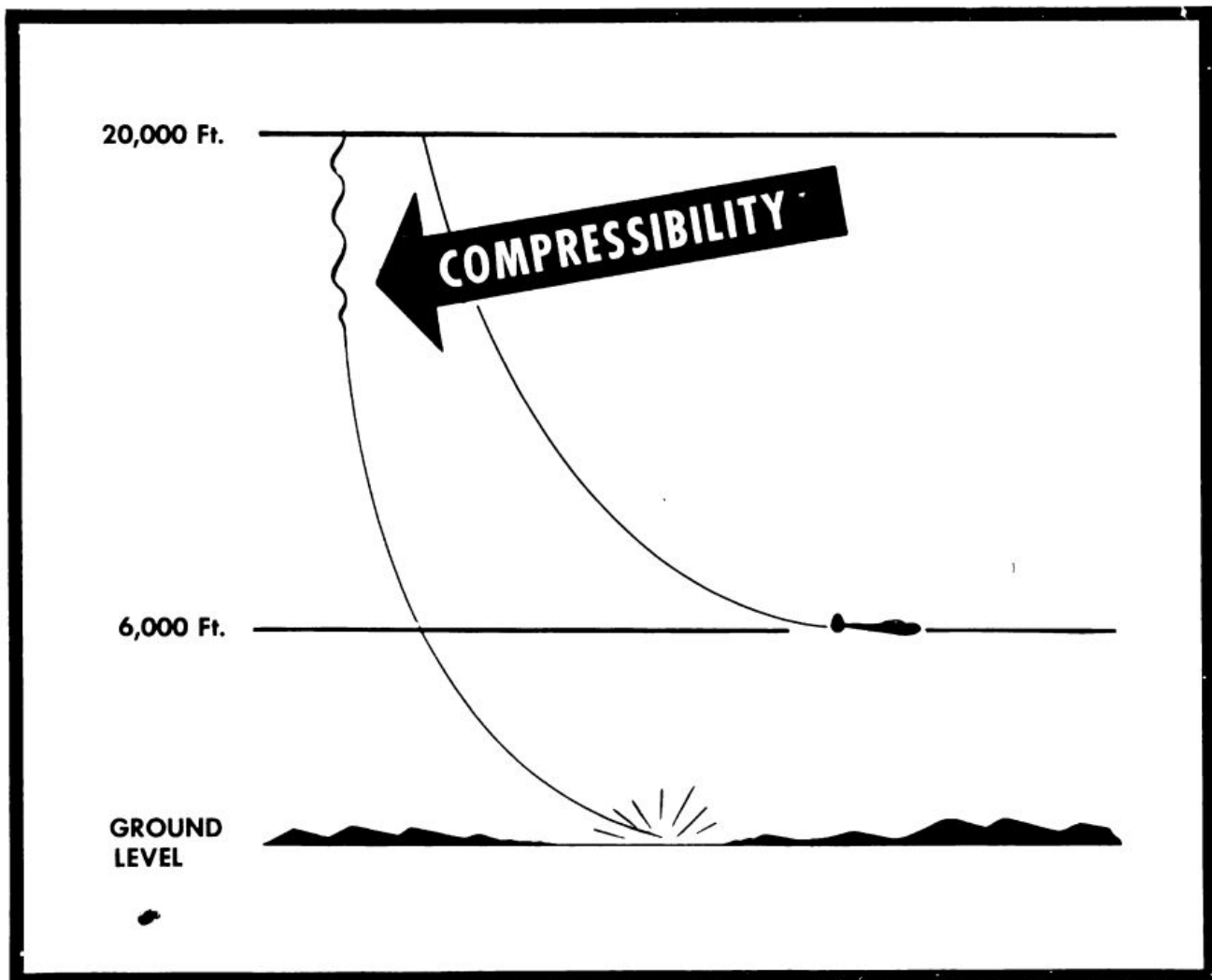

## COMPRESSIBILITY RECOVERY PROCEDURE

Most important of all, **don't get into compressibility**. But if you do get into compressibility in a high-speed dive, don't get excited. Keep cool; and follow this recommended recovery procedure:

1. Cut the power **immediately**. To get out of compressibility you have to lose airspeed, so pull your throttles back.

2. Hold the stick as steady as you can, maintaining a slight amount of back pressure. Too much back pressure will greatly increase the tail buffeting.

3. Use only a few degrees of elevator trim tab. Too much trim causes the airplane to pull out abruptly when a lower airspeed and altitude is reached.

4. As the airplane slowly but steadily decelerates with power off, and you get into the lower altitudes where the speed of sound is greater, the buffeting decreases and you can regain control of the airplane.

5. Pull out of the dive in a normal recovery. **Don't pull out abruptly**. Take it as easy as altitude permits.

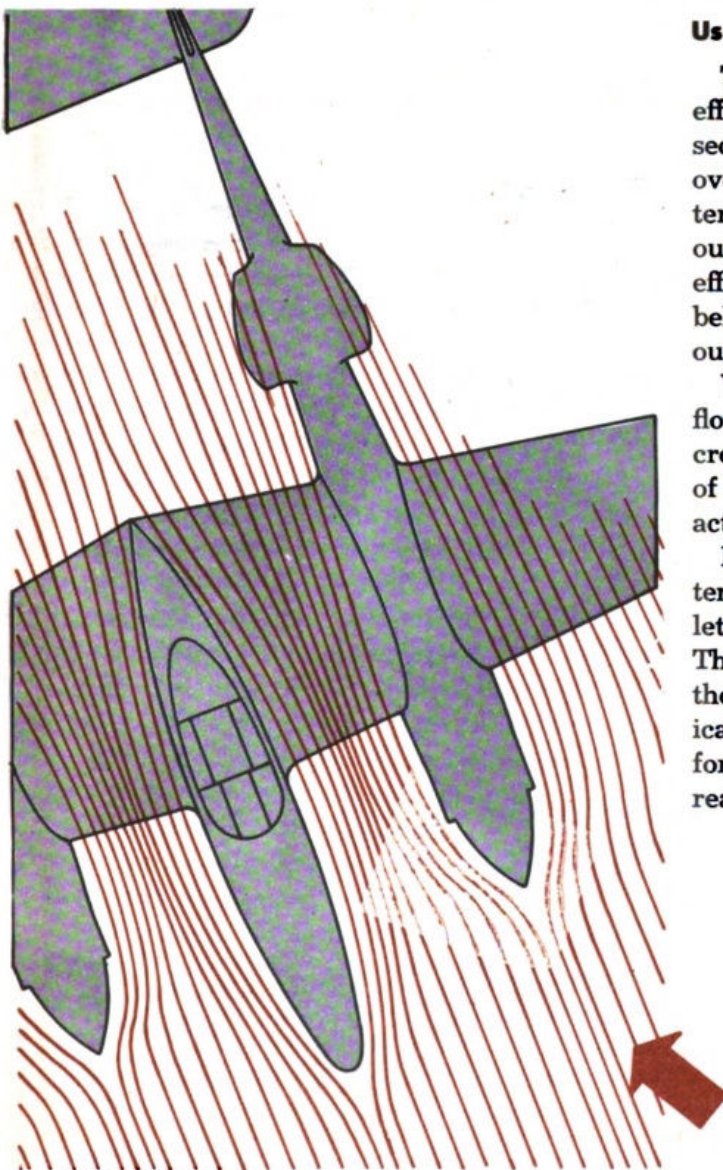

### Use of Dive Flaps

The gondola and nacelle create a venturi effect so that the air passing over the center section of the wing travels much faster than over the outboard section. Therefore, the center section goes into compressibility while the outboard section still has some aerodynamic efficiency. That is why the dive flaps are placed below and behind the leading-edge of the wing, outboard of the nacelles.

When you lower the dive flaps, they spoil the flow of air under the wing, creating an increase in lift efficiency on the upper surface of the wing. This destroys the noseheavy characteristics which are found in high speed dives.

It is recommended that the dive flaps be extended as soon as the dive is begun rather than let the speed build up and then extend the flaps. This provides much better control throughout the dive and minimizes the chances of mechanical failure. You don't have to lower them before you start the dive, but simply before you reach compressibility.

### VENTURI EFFECT CAUSED BY GONDOLA AND NACELLES

RESTRICTED



ENTERS SPIN FROM STALL WITH SNAP



## SPINS

### Characteristics

The P-38 enters a spin from a stall with a sort of snap roll. During the first two turns the nose alternately points steeply down, then up close to or above the horizon. This oscillation up and down gives the impression during the first couple of turns that the airplane is in a flat spin. Actually the nose does get up so that the plane is in a flat or level attitude. This is only momentary. During the third turn the oscillations dampen out and from the fourth turn on the attitude of the airplane is constantly in a fairly steep nosedown position, 30° to 40° below the horizon.

After the fourth turn, the spin remains constant. Regardless of how many turns the airplane is allowed to spin, recovery is accomplished in one turn with ease and rapidity.

There is considerable buffeting under some conditions, especially with gear down, but the characteristics of the spin remain the same.

Because of the oscillations and buffeting encountered in the spin it is important that you keep your safety belt tight.

The spin is fast, completing one turn every 3 seconds and losing about 1000 feet per turn. Although indicated airspeed during a spin is as low as 100 mph or less, the rate of vertical descent is over 200 mph. For this reason, deliberate spins are prohibited below 15,000 feet. At least one turn is required for recovery. You can figure on losing 2000 feet from the time you kick rudder against the spin until you have

AIRPLANE COMES OUT OF SPIN IN VERTICAL DIVE

MAKE GRADUAL PULL OUT FROM DIVE TO PREVENT SPIN IN OPPOSITE DIRECTION

completed the pullout. In a five-turn spin you lose at least 6000 feet before you are flying straight and level again.

### Spin Recovery

You can bring the airplane out of the spin any time by kicking full rudder against the spin. Hold it for a minimum of  $\frac{1}{2}$  turn, then ease the control column forward. Ease the wheel forward. Don't shove it forward. The airplane will come out of the spin when you have the wheel to neutral or a little beyond. During the spin you notice a substantial back pressure on the control column. Don't fight it. When you push hard rudder against the spin, holding it for at least  $\frac{1}{2}$  turn, the rate of rotation slows down and the back pressure on the control column is relieved.

You must wait at least  $\frac{1}{2}$  turn after kicking rudder against the spin before moving the control column forward. If you push the control column forward before, or simultaneously with, the rudder you aggravate the spin and the rate of rotation is increased. In a spin the bottom part of the rudders, below the horizontal stabilizer, is the only part that is effective. This is easy to understand when you picture the tail falling at an extremely high angle of attack with the airflow. The horizontal tail surfaces completely blanket out those portions of the vertical fins above them, which leaves only the lower portions of each vertical surface effective to bring you out. If you push the control column forward before, or at the same time as, you use the rudder, you further reduce the effectiveness of the rudders, because as the elevator travels downward it blankets out more of the rudder. With decreased effective rudder surfaces there is less tendency to slow down your rate of rotation, which must be stopped before recovery can be accomplished.

Remember! Rudder first for at least  $\frac{1}{2}$  turn, then ease the control column forward.

If you have difficulty in moving the wheel forward it indicates that your rate of rotation is too fast. Don't fight the control column forward. Wait a little longer with full opposite rudder and when the rotation decreases you will be able to move the wheel forward.

RESTRICTED

If you get into an accidental spin, above all, don't get excited. Since the airplane has no inherent tendency to spin, you can usually recover before the spin develops by simply straightening out with rudder and easing forward on the wheel.

The P-38 doesn't spin like a trainer. Because it's an extremely heavy airplane you can expect a rough ride. You may get thrown about in the cockpit and, because of its oscillations, you may find it difficult to orientate yourself with the ground.

With landing gear, flaps, or dive flaps extended it takes about one turn longer to recover. So if you have gear or flaps down when you enter a spin, start them on their way up.

**If you accidentally fall into an inverted spin, pull the stick back. This gets your nose down and develops a normal spin.**

Here is the recovery procedure:

1. Close throttles.
2. If gear or flaps are down, start them up.
3. Kick full rudder against the spin.
4. Wait at least  $\frac{1}{2}$  turn with rudder in, then ease the wheel forward.
5. The airplane comes out of the spin in a vertical dive. Recover from the dive slowly. Make a gradual pull-out. If you pull out too sharply you may stall and spin off in the opposite direction.



**DON'T USE AILERON AGAINST THE TURN. THIS HAS A BLANKETING ACTION ON THE RUDDERS.**



## SINGLE ENGINE PRACTICE

Sometime after your first 10 hours in P-38 you will practice single engine flight. This is done from cruising airspeed at not less than 8000 feet altitude. Your flight leader flies alongside and directs you by radio.

You will find that the P-38 flies very well on one engine. Using normal rated power, it can climb above 20,000 feet and have a TAS greater than 225 mph.

In practicing single engine flight, cut the right engine. The generator in most P-38's is on

the left engine. With the left engine dead the generator is not operating and the battery will go dead in about 30 minutes. If your airplane has two generators that are on and working you can practice feathering either propeller.

Check the ammeter, voltmeter, and fuel supply before you cut the engine.

Practice the procedure for single engine performance as though it were an actual engine failure. This prepares you for such an emergency.

The following practice procedure is designed to take care of an engine failure just after take-off or in flight with landing gear up and 130 mph IAS.

### Stopping Engine and Feathering

1. Close throttle of one engine. This simulates engine failure.
2. Maintain directional control with rudder using as much power from the live engine as you can hold.
3. Trim rudder to relieve pressure.
4. Move mixture control of dead engine to IDLE CUT-OFF.
5. Feather switch of dead engine to FEATHER.

### Care of Dead Engine After Propeller Is Feathered

1. Fuel booster pump OFF.
2. Throttle cracked.
3. Propeller governor control lever full rearward.
4. Propeller switch manual FIXED PITCH.
5. Return feather switch to NORMAL. This is important. You will be unable to unfeather unless feather switch is NORMAL.

### NOTE:

In single engine practice, do not turn off fuel supply or ignition of dead engine.

Use as little power as necessary from the good engine. Don't burn it up. With 2600 rpm and 35" manifold pressure, you can maintain an air-speed of 150 mph to 200 mph.

### Unfeathering Propeller and Starting Engine in Flight

1. Fuel booster pump ON.
2. Hold propeller switch to INCREASE RPM. The propeller will start windmilling.
3. When the tachometer registers approximately 1000 rpm, place the propeller switch to AUTOMATIC.
4. Move mixture control to AUTO RICH. Engine will start.
5. Trim the airplane.
6. Oil and coolant shutter switches in AUTOMATIC.
7. Run the engine at 20" Hg. and 1500 rpm until coolant temperature reaches 85°C and the oil temperature is at least 50°C. Then resume normal engine power settings.



# Check!

IF THE ENGINE DOESN'T START,  
CHECK THE FOLLOWING:

1. FEATHER SWITCH IN NORMAL
2. FUEL SELECTOR TO FULLEST TANK
3. IGNITION SWITCH ON

# LANDING

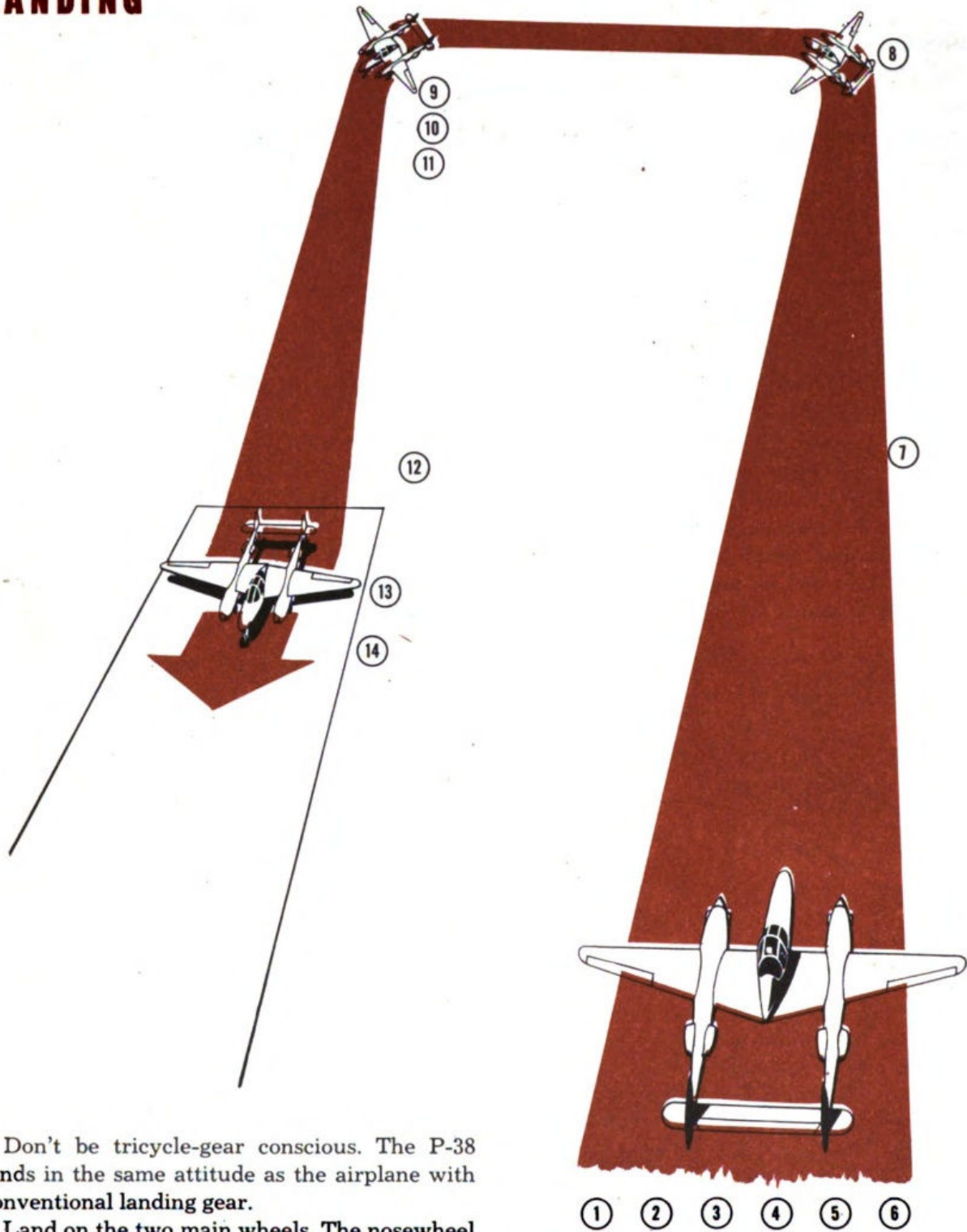

Don't be tricycle-gear conscious. The P-38 lands in the same attitude as the airplane with conventional landing gear.

Land on the two main wheels. The nosewheel settles of its own accord.

**Landing Procedure**

1. Fuel selectors to fullest tanks.
2. Fuel booster pumps ON.
3. Propellers at 2600 rpm.
4. Mixture in AUTO RICH.
5. Intercooler shutters OPEN (if installed). This is not necessary during cold weather operation.
6. Lift flap trigger through quadrant notch leaving flap control handle in CLOSED position.
7. Slow up on downwind leg to 175 mph and lower landing gear. Don't cut the throttles to slow down. Reduce them gradually and maintain at least 15" manifold pressure. If you cut the throttles, the engine will backfire and possibly load up.  
Make the following thorough check to be certain gear is down and locked:  
Hydraulic pressure . . . . .returned to normal.  
Hand pump . . . . .resists operation.  
Warning light . . . . .out.  
Polished area . . . . .nosewheel down.
8. Turn on base leg at 150 mph.
9. Make final turn into field at 150 mph.
10. Drop full flaps and trim elevator.
11. Start glide at 130 mph, carrying at least 15" manifold pressure. Gradually reduce this power and airspeed and,
12. Come over the fence at 110 mph.

**Perfect your landing approach technique. It requires skill and judgment and is one of the tests that determine a good pilot.**

Don't drag your approach in from miles back. On long, low approaches, an engine failure leaves you in an embarrassing situation.

Too high an approach is just as bad. Don't look as if you are going to dive bomb the field.

13. Contact is made between 90 mph and 100 mph. Land with your heels on the floor. Keep your feet off the brakes.

Land on the two main wheels, holding the nosewheel off the ground. With full flaps down you can't drag the rudder fins on the runway. With 1/2 flaps or less you can.

14. After contacting the runway, keep the airplane straight. Steer with the rudders as long as they are effective. Do not use brakes unless necessary. Then apply them on and off.

**Tip:** Be prepared to encounter prop wash when landing behind another airplane. If you hit prop wash, correct immediately! Don't sit there fat, dumb, and happy while the airplane does a snap roll.

Make every approach and landing with the same care and concern as you did on your first solo.

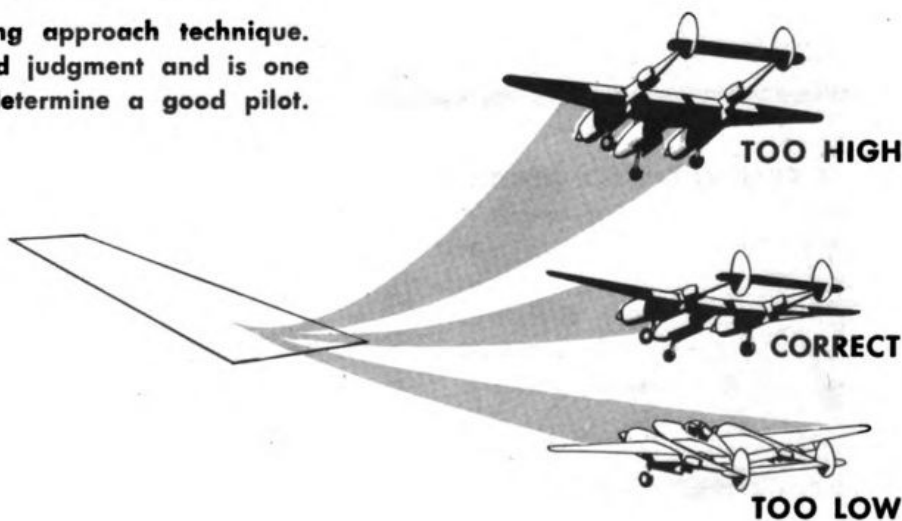

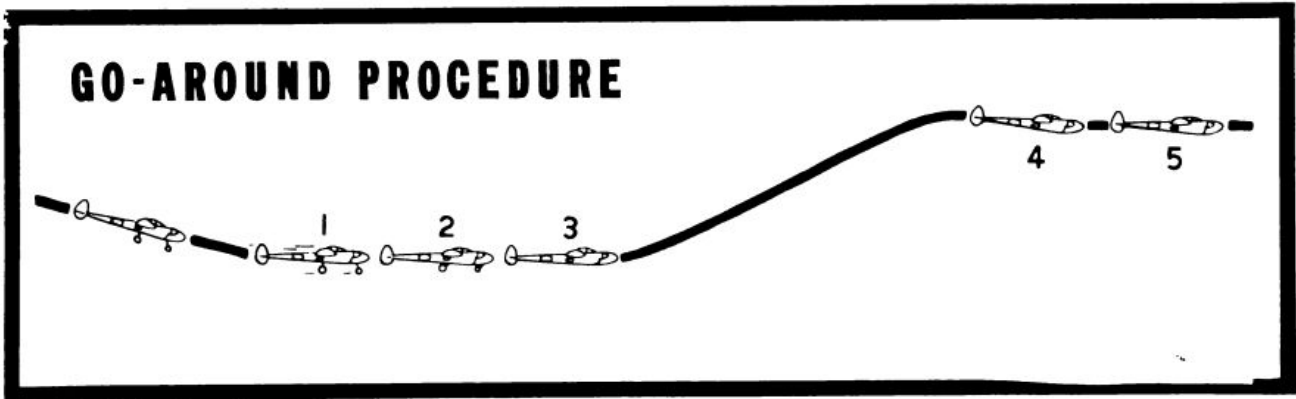

If you overshoot and cannot land in the first third of the field, go around.

If for any reason you do not feel that everything is just right, go around.

You will not be criticized. It will be considered good judgment. But try to make up your mind early. Don't wait until you are half-way down the runway.

In going around, use the following procedure:

1. Steadily advance throttles to takeoff manifold pressure.
2. Retract the landing gear.
3. Climb straight ahead and gain at least 500 feet altitude.
4. Lower nose slightly and build up airspeed.
5. Milk up the flaps.

Don't try to fly around the field with gear and flaps down; don't turn until flaps are up.

## CROSSWIND LANDINGS

A crosswind landing in a P-38 presents no problem because of the tricycle landing gear.

With the tricycle landing gear the center of gravity is **forward** of the main wheels. Once the wheels have touched the ground, the P-38 rolls straight down the runway. It will not groundloop.

On the final approach, crab or lower a wing into the wind, or use a combination of both.

Be sure you straighten out before making contact. Do not land in a crabbed or one-wing-low attitude. The gear was not built to take excessive side stress.

Immediately upon landing, put the nose-wheel on the runway to obtain directional stability and roll straight down the runway.

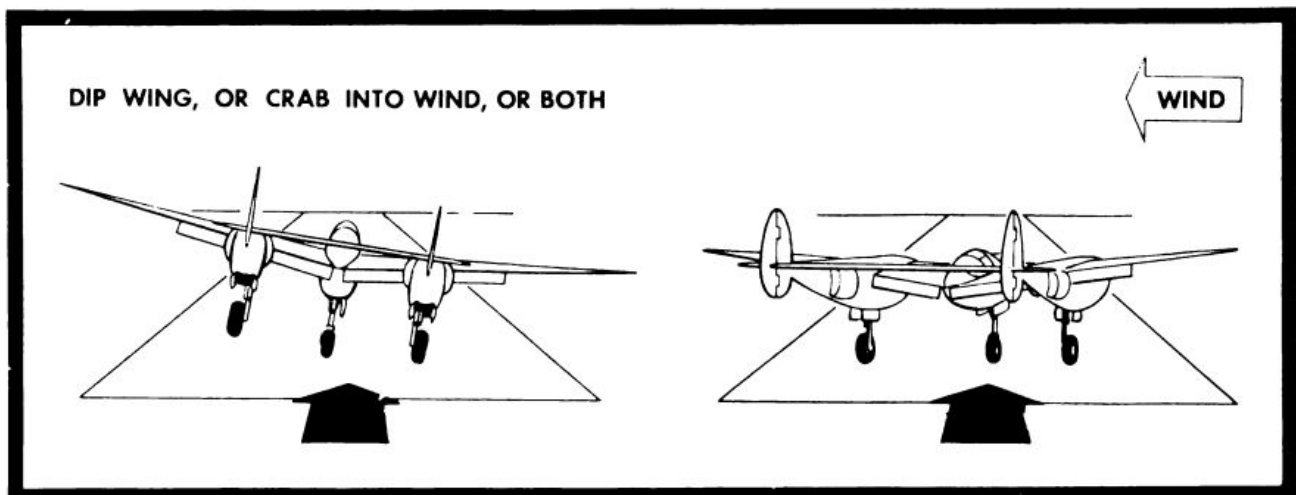

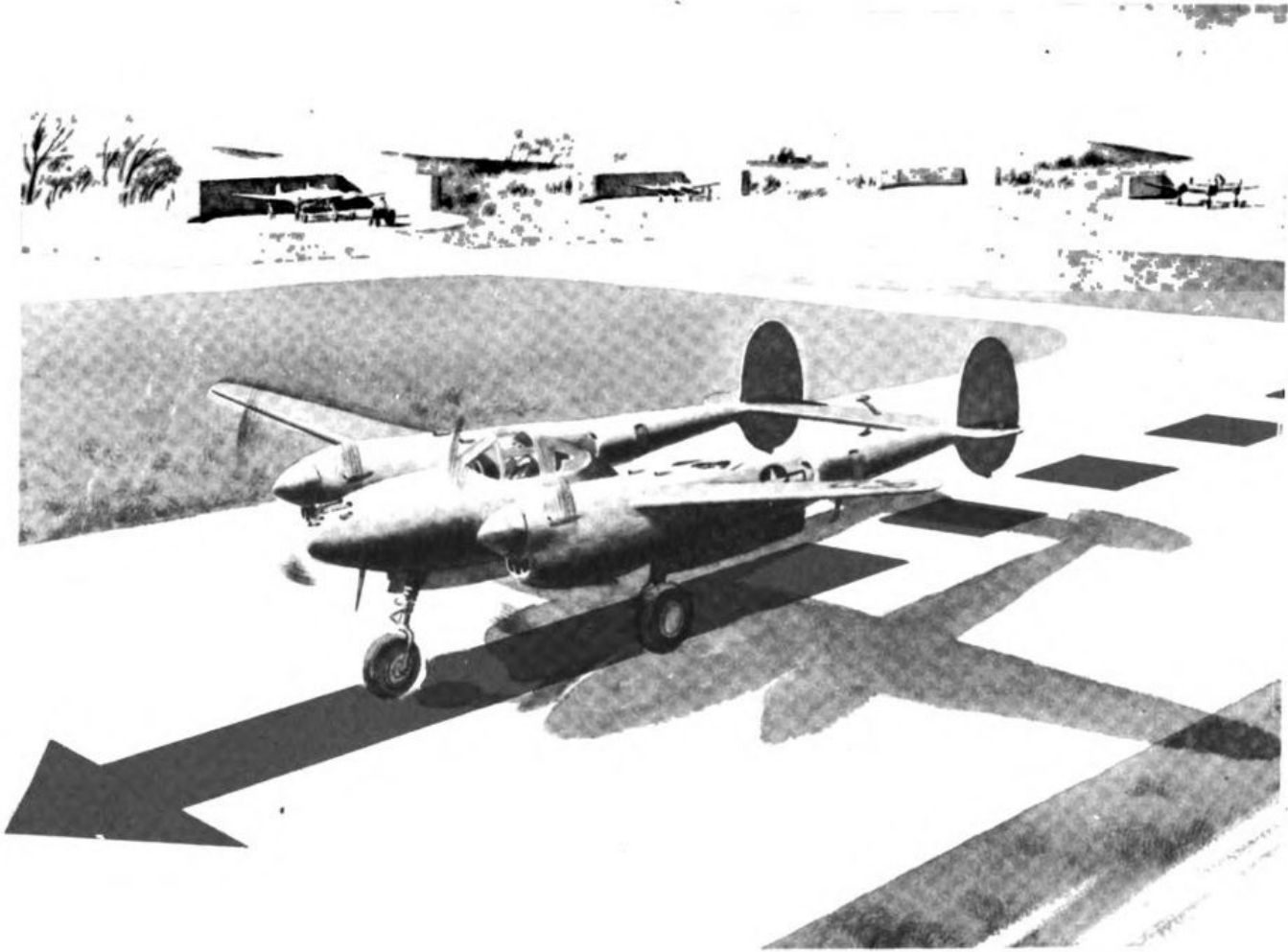

## AFTER LANDING

Keep the airplane straight with rudder. Avoid unnecessary use of the brakes.

Don't raise the flaps until you have reached the end of the runway. This helps you slow the airplane.

After you have slowed down, pull your flaps up, turn the booster pumps OFF; push the propeller governors full forward, and set the trim tabs to 0. Then place the oil and coolant shutters in FULL OPEN. This helps keep the temperatures down while you taxi.

Don't set the parking brakes after you have returned to the line. The brake discs get hot while taxiing and will freeze if you set them. After you have turned the engines off, hold the brakes until chocks have been placed.

RESTRICTED

### To Stop the Engines

1. Open throttles to 1600 rpm.

**Note:** Hold this for a few seconds to burn out any impurities that may have collected on the spark plugs while taxiing.

2. Return throttles to 1200 rpm.
3. Move mixture controls to IDLE CUT-OFF.
4. When engines stop firing, open throttles.
5. When the propellers stop rotating, turn all switches OFF.
6. Turn fuel selectors OFF.

87



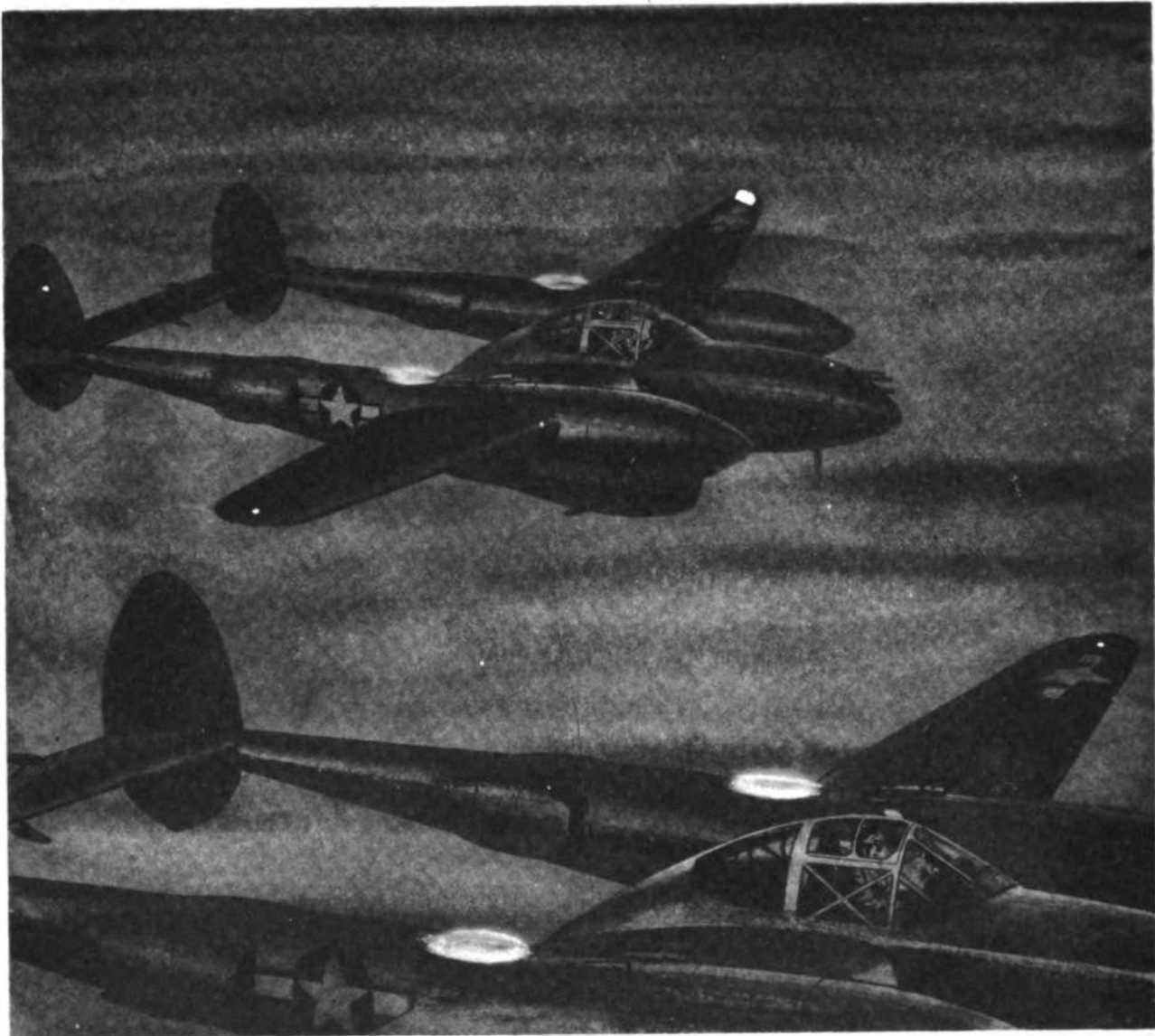

## NIGHT TRANSITION

You will do almost all your flying during daylight hours. But there will be times when you take off in the wee hours of the morning and sometimes in the late afternoon, coming home after dark.

Night flying in a P-38 presents no problem. But there are several precautions you must remember. Here are a few tips to help you:

### **Before Takeoff**

Equip yourself with a flashlight.  
Make the **Additional Check for Night Flying.**

- Check gage for approximately 4" of vacuum and uncage gyro flight instruments.
- Check to see that aileron boost is ON.
- Set altimeter.
- Use of oxygen from the ground up improves your night vision.
- Establish radio contact.
- Taxi slowly, intermittently using landing light if necessary.
- Turn the landing light off when a plane is landing.
- Get radio permission to take off.
- Pick a point at the end of the runway to keep you straight on your takeoff run.

**During flight**

Proceed to your assigned zone and altitude.  
Remain in your zone until called by the tower.  
Keep your head on a swivel.

Frequently check your instruments and fuel supply.

A turn can change contact flying to instrument flying. If you lose the horizon, immediately go on instruments until you definitely establish your attitude. Don't fly by the seat of your pants.

Always keep the field in sight.

Don't make steep turns at any time.

**Important:** If radio contact fails, turn on your landing light and point your plane at the tower. When they give you a green light, go in and land.

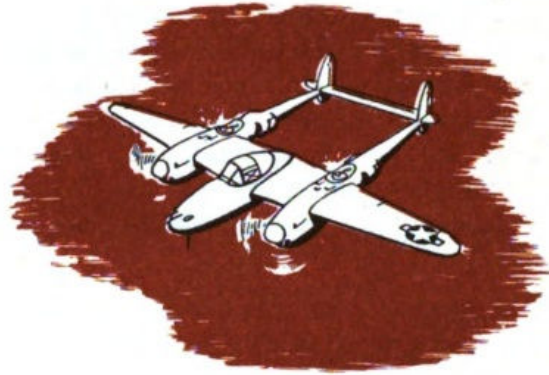
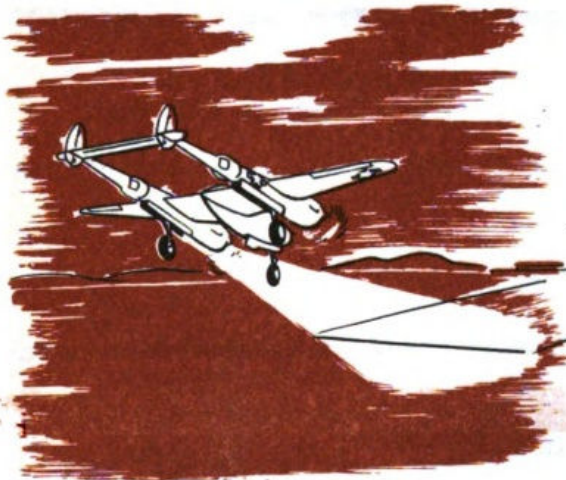

If an emergency occurs, immediately start your letdown for landing and turn on your landing lights. This is your emergency clearance. Don't be alarmed by the glow of the turbo-superchargers.

**Landing**

When you retard the throttles, sparks and perhaps flames will appear. Don't be alarmed. It's there in the daytime, too, but you can't see it.

Maintain a minimum of 1000 feet in the pattern until you turn into the final approach.

Use of landing lights and floodlights is optional. If there is haze or dust over the field, a blackout landing is recommended.

Go-around procedure is the same.

A safety officer will be in the tower or in a radio truck. Help yourself by observing his instructions.

**INSTRUMENT FLYING**

Under the present system, you receive instrument training under a hood while flying formation with your instructor. The instructor has contact with you by radio and can tell you to come out from under the hood if there are any airplanes in the vicinity. As a precaution in case of radio failure, come out from under the hood every 3 minutes and look around.

**RESTRICTED**

**RESTRICTED**

**Instrument Letdown Procedures**

The P-38 is very stable in instrument conditions. If you have to climb up through an overcast or let down through one, establish your power settings and airspeed while still on contact. Go on instruments at least one minute before actually entering instrument conditions.

**Preparations Prior to Instrument Letdown**

1. Pitot heat on.
2. Check vacuum at approximately 4" to insure proper rotor speed of gyro instruments.
3. Set gyro instruments.
4. Lower landing gear. This creates greater stability and helps keep the airspeed down.
5. Lower maneuver flaps. This reduces the wing loading giving you added control.

**Power Settings to Descend at 180 mph IAS**

**P-38L**

Rate of Descent	Manifold Pressure	RPM
500 ft/min	28"	2600
1000 ft/min	25"	2600

**P-38J**

500 ft/min	24"	2600
1000 ft/min	20"	2600

**Note:** The above power settings vary with loading and differences in gross weight.

Never attempt an instrument let down unless you have radio contact, your position has been established, and you have received authorization and instructions from a radio clearing authority such as a direction-finding fixer station.

Never make a spiral let down or exceed a one needle width turn.

Be particularly cautious not to exceed 200 mph IAS. Your airspeed can build up very rapidly. Never make an instrument let down at high speeds. Gyro instruments at high speeds aren't dependable.

When flying formation during instrument conditions, the sole duty of each wingman is to concentrate on flying heads-up formation. Only the flight leader will be on instruments. The formation letdown procedure is the same as for single aircraft.

**ANGLE OF BANK IN RELATION TO AIRSPEED FOR STANDARD RATE TURN**

Indicated Airspeed	Angle of Bank
150	20°
180	23°
200	26°
225	30°
275	38°
300	42°

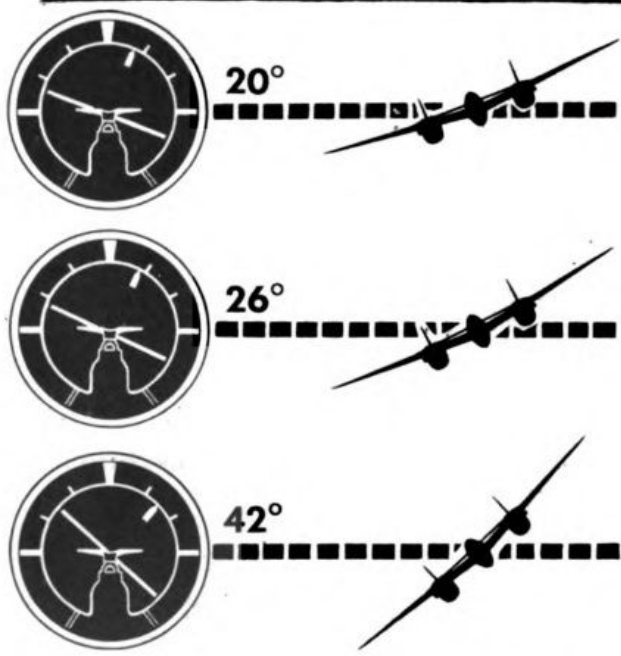

# SECTION 4 Emergencies



## ENGINE FAILURE

When an engine conks out on a single engine fighter, the first thing the pilot does is look around for a place to make a forced landing. If he happens to be above an overcast, rough terrain, or a heavy sea, his best bet is to hit the silk. If his engine fails on takeoff he has no other choice but to glide straight ahead. You, as a P-38 pilot, are not faced with this problem. If an engine fails after takeoff or during flight, you still have a good single engine airplane under you. Follow the same procedure as outlined in **Single Engine Practice** on page 83.

The minimum airspeed at which you can fly the P-38 on one engine is 130 mph **with landing gear up**. It can happen that one engine quits on takeoff when you don't have 130 mph with the gear up.

### With Less Than 130 MPH

If an engine fails, or there is any irregularity, between the start of the takeoff run and 130 mph IAS, **cut both throttles and stop**.

If you cannot stop on the runway, retract the gear and slide in. Use the landing gear emergency release knob to lift the control handle.

### With 130 MPH or More

If an engine fails after you have left the ground and the landing gear is up, or starting up, and you have a minimum of 130 mph IAS, do the following:

1. Reduce power to gain directional control. Correct yaw with rudder, applying as much

power as you can hold.

2. While correcting yaw, release drop tanks (if installed).

3. Move mixture control of bad engine to **IDLE CUT-OFF**. Be certain you pull the mixture control of bad engine.

4. Feather propeller of bad engine.

5. Trim to take pressure off rudder pedal.

The most important thing to remember is the first step. Come back on the power, gain directional control with rudder, and then apply as much power as you can hold. Use rudder and not aileron to correct the initial yaw. Use of aileron increases the drag on the dead engine side. Don't apply so much power on the live engine that you can't hold the airplane.

The landing gear, when down, offers 60% of the total drag. Be sure the landing gear has been retracted, or is on its way up. An IAS greater than 130 mph is what you are striving for. Put the nose down to gain extra speed.

## *Sacrifice Altitude for Airspeed*

Try to maintain a level climb away from the field. **Don't get excited** and try to turn back and land. Get plenty of altitude and fly around until the ship feels comfortable. You may be able to find out the trouble and restart the engine. If not, with the assistance of an experienced pilot in the tower you can take your time and make a well-planned single engine landing.

## RESTRICTED

### Single Engine Range

For maximum single engine range, use the lowest power which maintains an IAS of approximately 160 mph.

Use fuel from the dead engine side first. This lessens the load and reduces the trim.

**Caution:** Your range and time in flight on one engine is less than the range and time in flight on two engines.

With drop tanks installed, use the fuel from the tank nearest the dead engine. Drop them when empty if it is necessary to increase your range.

**If the left engine has failed, and you do not have a generator on the right engine, take action as indicated under Electrical Failure.**

**Note:** Keep aileron boost ON until coming in for a landing. There are no aileron trim tabs and aileron boost relieves aileron pressure on long trips.

### Single Engine Landing Traffic Pattern

If you have to make a single engine landing and are carrying drop tanks, release them over an unpopulated area. If your airplane has aileron boost control, make sure it has been turned OFF so that you have all available hydraulic pressure to lower landing gear and flaps.

You can maintain altitude on single engine

with landing gear down. However, you cannot maintain altitude on one engine with full flaps and gear down. If on the final approach you have landing gear and flaps down, you have committed yourself and a landing must be made.

Maintain a minimum of 150 mph until you are on the final approach. Make all turns, whenever possible, into the live engine.

The single engine landing traffic pattern differs from the normal approach. The following procedure has proven to be the most satisfactory.

1. Secure radio clearance for emergency landing.
2. Turn aileron boost control OFF so that you will have all available hydraulic power to lower landing gear and flaps.
3. At 160 mph, 4000 feet above the terrain, about 5 miles from the end of the runway, lower the landing gear. The extension time will be doubled (or approximately 30 seconds) because only one hydraulic pump is working.
4. Lift trigger on flap control handle through notch.
5. Come over end of runway at 3500 feet above terrain at 150 mph and start turn into live engine, descending until—
6. At completion of 360° turn you are 1 mile from end of runway at 1000 feet above terrain.
7. When you are certain you can make the

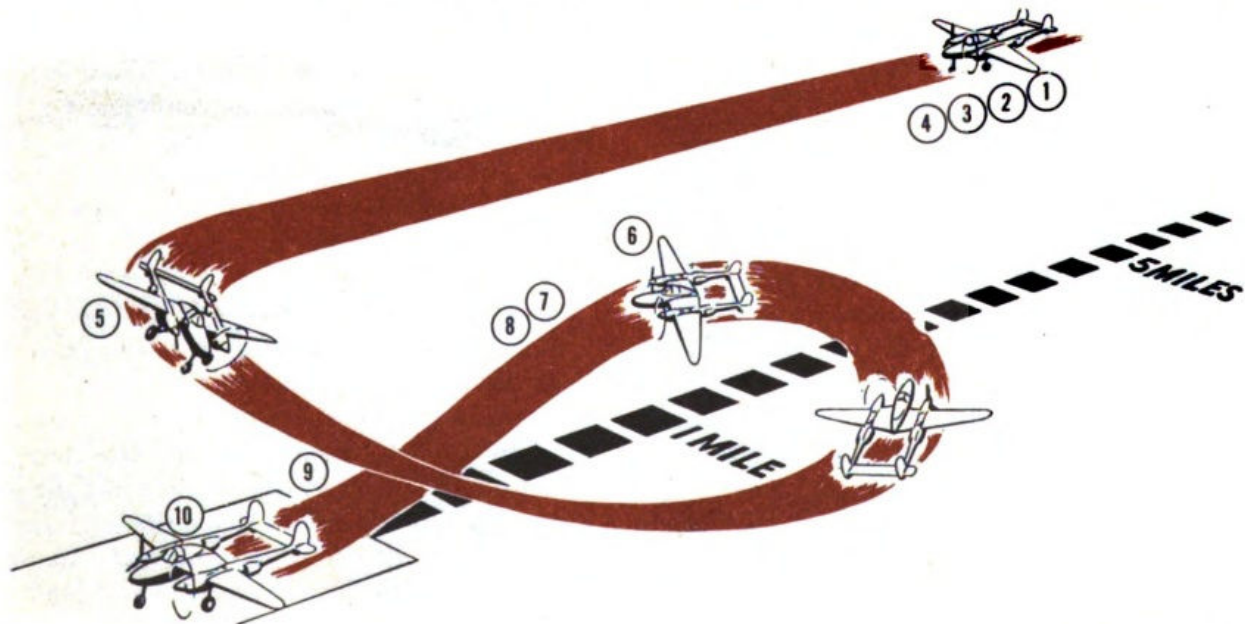

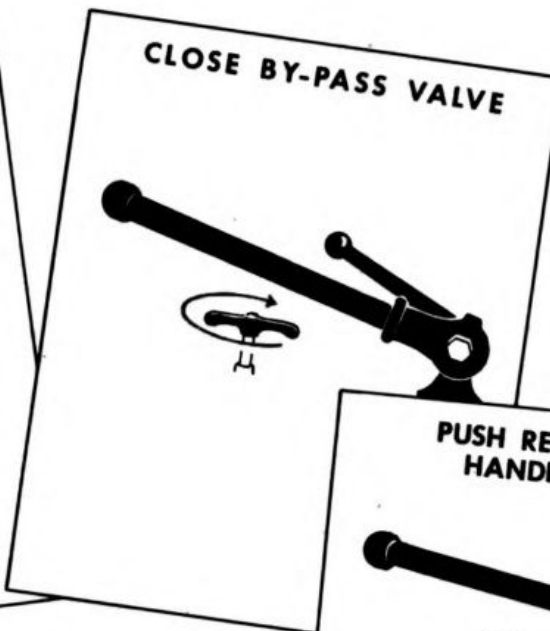
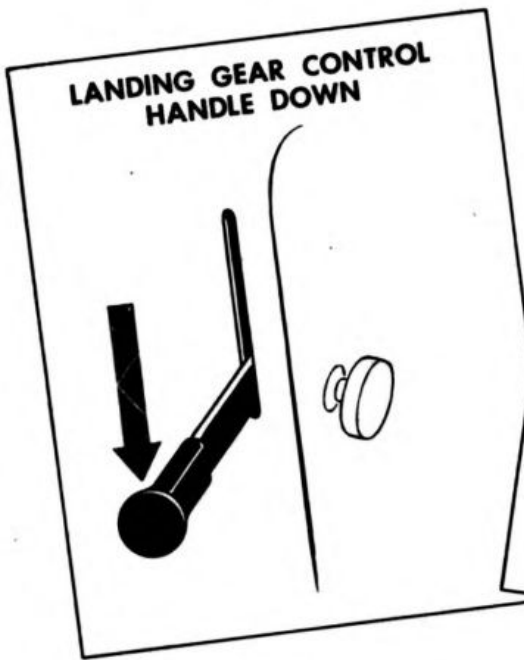

TO LOWER  
LANDING  
GEAR WITH  
EMERGENCY  
EXTENSION  
SYSTEM

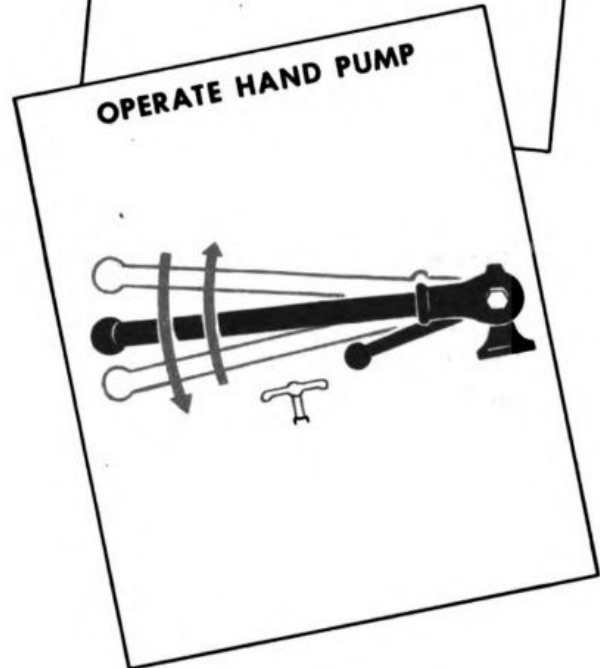
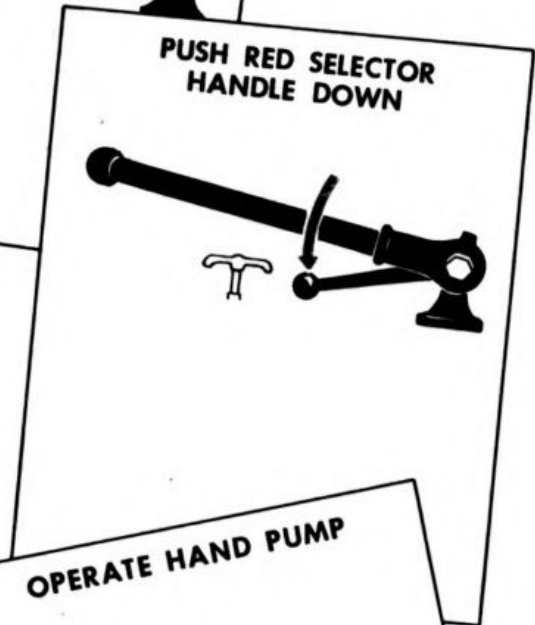

field with power off, lower full flaps. Remember, with full flaps your glide angle is increased.

8. Keep the airplane trimmed.

9. Come over the end of the runway at 110 mph.

10. Make a normal landing.

## HYDRAULIC FAILURE

### Auxiliary System

Two conditions are usually the cause of hydraulic system failure. Either the engine hydraulic pump has gone out or there is a break in the hydraulic line. If the engine pump goes out there is still hydraulic fluid in the system and you can extend the gear and the flaps with the auxiliary hand pump. It is necessary, however, that you turn OFF the coolant override switches and aileron boost control. Place the landing gear control lever in the DOWN position and no other action except pumping is required.

The engine pumps drain the hydraulic fluid from the top two-thirds of the hydraulic reservoir while the hand pump drains from the bottom third. So, if there is a leak in the hydraulic system, only the top two-thirds can drain out.

**NOTE:** Coolant override switches and aileron boost valve must be off to operate auxiliary hand pump.

RESTRICTED

## RESTRICTED

This leaves you the bottom third; enough hydraulic fluid to lower gear and flaps, with the hand pump supplying the pressure.

This auxiliary system uses the same lines as the normal hydraulic system.

### Emergency Extension System

If the main hydraulic reservoir is empty or the lines are broken, you cannot build up any pressure with the hand pump alone. Use the emergency extension system.

This system is completely independent of the normal system. It has separate hydraulic lines and its own hydraulic reservoir. The hand pump is its power supply. After you have opened the system, all you need to lower the gear is a little elbow grease.

Since this system works off a separate set of hydraulic lines, there is no indication of pressure on the hydraulic pressure gage.

There is sufficient hydraulic fluid in the emergency system for only one operation. You can lower the landing gear **and that is all**. You can't retract the gear with this system.

A by-pass valve and selector valve (red handle) are on the floor to the right of your seat. When you close the by-pass valve, you shut off the regular hydraulic lines and open the lines from the emergency reservoir. Place the red handle down and the emergency fluid flows into the lines. **The P-38J and P-38L series do not have the by-pass valve. The red handle incorporates the action of the by-pass valve.**

Use the following procedure to lower the landing gear:

1. Coolant override switches OFF (if installed).
2. Aileron boost control OFF (if installed).
3. Landing gear control handle DOWN.
4. Close the by-pass valve by turning it clockwise.
5. Place the red handle in the DOWN position.
6. Operate the hand pump.

Pumping may be difficult at first because the wheel doors have to be forced open.

**Tip:** With the landing gear control handle in the DOWN position, dive the plane and pull out

abruptly. Do this a few times. The centrifugal force helps open the wheel doors and lower the gear.

### Emergency Operation of the Flaps

Use the hand pump first for flap extension because in some cases there may not be sufficient fluid in the main reservoir to extend both the gear and the flaps. You can lower the gear with the emergency extension system.

1. Coolant override switches and aileron boost OFF.

2. Extend the flaps  $\frac{1}{2}$  down by operating the auxiliary hand pump.

3. Lower the landing gear, then lower the flaps completely.

4. If you used the landing gear emergency extension system, raise the red handle to the UP position, and leave the by-pass valve in the CLOSED position. This maintains pressure on the landing gear cylinders, insuring that the landing gear downlocks remain properly engaged.

If one engine has failed in addition to the hydraulic system, remember, the airplane cannot maintain level flight on one engine with both landing gear and flaps down. Under such conditions, land with your flaps up.

## ELECTRICAL FAILURE

Electrical failure may be indicated by a zero reading on the ammeter. The first indication of generator failure and a low battery is failure of the radio. There may still be sufficient battery power to adjust the propellers for a safe landing. Under these circumstances, do the following:

1. Turn all electrical equipment OFF.
2. Set propellers in manual FIXED PITCH.
3. Turn battery switch OFF.
4. Proceed to the place you are going to land.

You can't fly at high altitude with the generators and battery dead. The electric booster pumps are necessary to supply sufficient fuel pressure to feed the engines. If the electrical system is dead, or you turned the booster pumps OFF to conserve the battery, it will be

RESTRICTED

necessary for you to descend below 10,000 feet so that fuel pressure can be supplied by the engine-driven fuel pumps.

**Note: With booster pumps OFF, fuel cannot be drawn from the outer wing tanks.**

If it is necessary for you to land with the propeller switches in manual FIXED PITCH make the following settings to insure go-around rpm and power:

1. Circle at 5000 feet above the field.
2. Set manifold pressure at 25" Hg.
3. Slow airplane to 180 mph IAS.
4. Turn battery switch ON.
5. Set propellers at 2600 rpm using manual INC or DEC positions of propeller switches.

### High Amp Reading

High amp reading indicates a low battery or a short in some electrical accessory. Here's the test that determines which it is and what to do about it:

1. Turn the battery switch OFF. If the amp reading goes down to normal, the battery is low.

2. Turn the battery switch ON and in time the battery recharges and the amp reading comes down.

If the amp reading remains high after all electrical equipment and battery has been turned off, it is a faulty indication of the ammeter.

---

## EMERGENCY RADIO PROCEDURES

Definite radio procedures are necessary when you have decided to bail out over water or ditch. Each theater has its own radio procedure. You will get the full details when briefed for a mission.

If there is opportunity and time, try to gain altitude, especially if below 5,000 feet. This increases the range of your transmission and helps Air/Sea Rescue Units get a good fix. How quickly you are rescued may be determined by the accuracy of the fix. Given below is a typical radio procedure for bailout over water or ditching.

1. Notify wingmen that you are in trouble.
2. Turn on IFF emergency.
3. Transmit "Mayday" (three times) followed by call sign of aircraft (three times).
4. First transmit on the assigned air-ground frequency. If you are unable to establish communication on the assigned air-ground frequency, use any other available frequency in

an effort to establish contact with a ground station.

5. If time permits, transmit the following information:

- a. Estimated position and time.
- b. Course and speed.
- c. Altitude of the aircraft.
- d. Your intention as to ditching, bailing out or crash landing.

Immediately prior to ditching, bailing out or crash landing, break the safety wire and place the VHF control switch on the T position to obtain continuous transmission.

If you overcome an emergency, after sending a distress message, cancel the message on the same frequency.

Wingmen or flight members, on hearing a distress call, should if possible orbit the spot, one plane going down low, the other remaining high and continuing transmission of distress signals. This insures that a good fix is obtained.



## EMERGENCY LANDINGS

The P-38's exceptional single engine ability will bring you home if one engine fails. If both engines fail or you run out of fuel, you have to decide whether to bail out or make a forced landing. There are many circumstances you must consider such as altitude, weather, and the type of terrain you are flying over. These factors have a great bearing on what you decide to do.

If you decide to make a forced landing, and can control the choice of a place to sit down, pick a spot near a road, phone line, small town or other settlement. This insures you immediate medical attention, or quick communication if medical aid is not on hand.

### Prepare for the Landing

Unless you are lucky enough to find an airport under you, land with your wheels up. Don't attempt to land wheels down on anything other than a smooth hard surface and where you have plenty of room. Get rid of drop tanks. If you are carrying bombs, release them on SAFE.

Next, after you have selected your spot to land, unfasten your parachute harness so that after you land you can get out of the cockpit in a hurry. Make sure your shoulder harness and safety belt are on and locked. If you are wearing a Mae West, inflate it to take up some

of the shock. Release the canopy and you are ready to land. Don't feather the propellers. Feathered propellers don't bend on impact. They dig into the ground, rupturing wing tanks and engine mounts, creating a fire hazard.

### Landing the Airplane

Remember that with your wheels up the reduced drag increases the gliding distance of the airplane. Plan your approach so that you will land straight ahead and won't have to turn low to the ground. Land as nearly into the wind as possible. Lower flaps as necessary to get you into the place you want to land, but have full flaps before contact. This decreases your groundspeed and stalling speed. Cut the switches, mixture controls, and boost pumps to reduce fire hazard. Land in a normal attitude.

As soon as the plane comes to a stop, get out of the cockpit and away from the airplane. Fires have been known to start many minutes after a belly landing.

### Belly Landings

If you come back to your field, lower the landing gear control handle, and find that the gear won't lower, that doesn't mean you have to make a wheels-up landing. Thoroughly and exhaustively try all methods of gear extension (**Refer to Hydraulic Failure**). Contact your squadron by radio and an experienced pilot will go through the entire procedure with you. As long as your fuel lasts you have time to work on getting the gear down.

When you are absolutely convinced that you can't get the gear down, inform the tower and prepare for a belly landing. The procedure is the same as outlined in **Emergency Landings** except that you have plenty of time and have a runway to land on.



# DITCHING

Never attempt to ditch the P-38 except as a last resort. Although it is possible to ditch the P-38 successfully, it is a hazardous business.

If trouble arises when you're on an overwater flight and you're sure that you can't reach land, don't hesitate to bail out. You won't be able to save the airplane anyway in landing on water, so you might as well abandon it in the air.

If it isn't possible to get up high enough to make a successful parachute drop, remember that the P-38 can be ditched successfully.

Your best chance for rescue lies in correct and speedy radio procedure before ditching. See **Emergency Radio Procedures**.

## Approach and Touchdown

Determine the direction of your approach well in advance. Touchdown parallel to lines of crests and troughs in winds up to 35 mph. Ditch into wind only if wind is over 35 mph or

if there are no swells. Use only half flaps. The retraction mechanism is such that when full flaps are down, surface pressure can't force them up, tending to force the nose under before complete loss of speed. In every case try to ditch while power is still available. Touchdown in a normal landing attitude.

The recommended ditching procedure is as follows:

1. Jettison tanks or bombs if you're carrying any.
2. Unfasten the parachute harness.
3. Make sure that your shoulder harness and safety belt are locked and tight.
4. Jettison the canopy and open both side windows.

Once the airplane stops you won't have more than a few seconds, so fix in your mind the following procedure:

1. Release the safety belt.
2. Jump out and pull the one-man life raft loose from the parachute.
3. Inflate your Mae West. If possible, salvage the parachute. It will come in handy.
4. Inflate the life raft and wiggle into it.

Even in shallow water don't get out of your Mae West until you are safely on shore.

See PIF for further information on Ditching.

## WIND VELOCITIES

Few white caps . . . . .	10 to 20 mph
Many white caps . . . . .	20 to 30 mph
Streaks of foam . . . . .	30 to 40 mph
Spray from crests . . . . .	40 to 50 mph

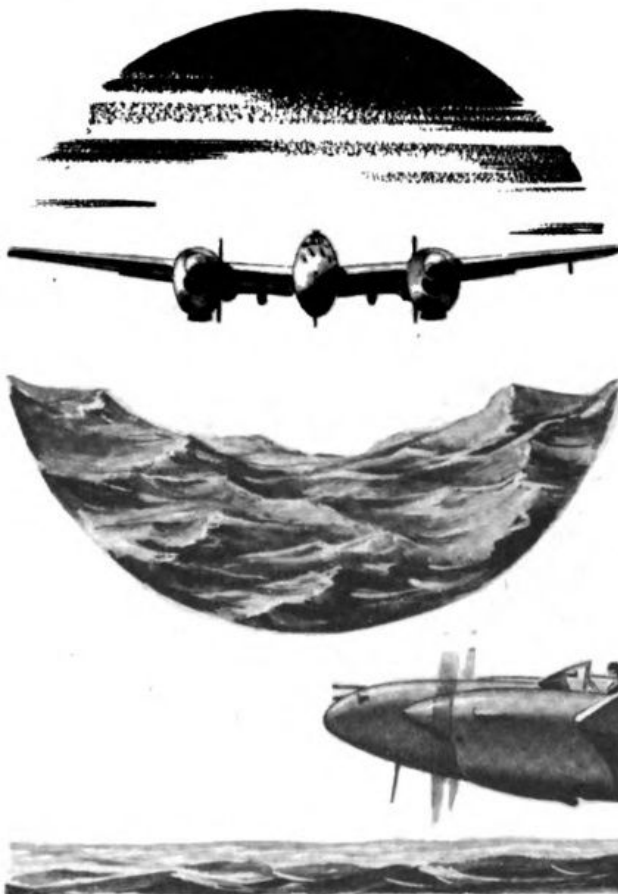



## BAILOUT

Many stories have been circulated that you can't successfully bail out of the P-38. Rumor had it that you wouldn't have a chance of missing the horizontal stabilizer, and twin booms and rudders. Actual experience has disproven these stories. In spite of the hangar talk that crops up from time to time, it is **no more difficult to bail out of a P-38 than any present-day fighter.**

Before you bail out, if you have the time, make the necessary radio calls as outlined in Emergency Radio Procedures. If you bail out over water or unpopulated territory, your best chance for rescue lies in correct and speedy radio procedure before you abandon your airplane.

The method of leaving the plane is largely dependent on your altitude, attitude, and air-speed. The final decision on how to get out rests with you. Here are three recommended and accepted procedures for bailing out.

### **Over the trailing edge of the wing**

1. Head towards an unpopulated area and disconnect oxygen tube and radio equipment.
2. Slow the plane down as much as possible.
3. Roll down the left window and release the canopy.

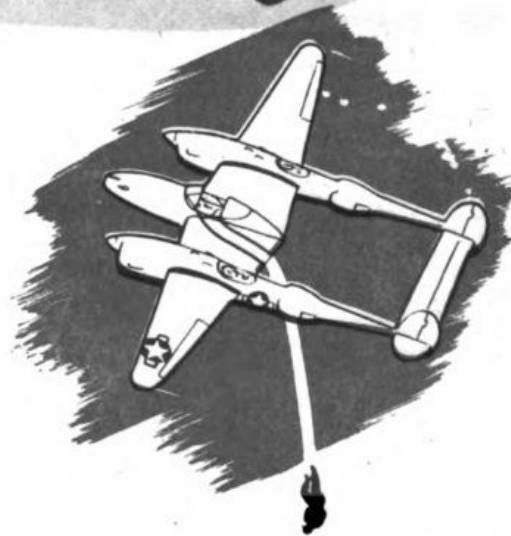

4. Release your safety belt and **slide out head first** off the trailing edge of the wing. **Never stand up or jump!**

**YOU WILL CLEAR THE HORIZONTAL STABILIZER**

### Roll the plane over and drop out

1. Disconnect oxygen tube and radio equipment.
2. Roll elevator trim tab forward while holding plane level. (This will keep the nose of the plane up while you are on your back.)
3. Release the canopy and roll the plane over on its back.
4. Unhook your safety belt and drop out.

Unless you are very low to the ground, keep your hand off the ripcord when leaving the plane. If you hold the ripcord handle as you bail out, the slipstream jerks your arm and the chute opens before you are clear of the plane.

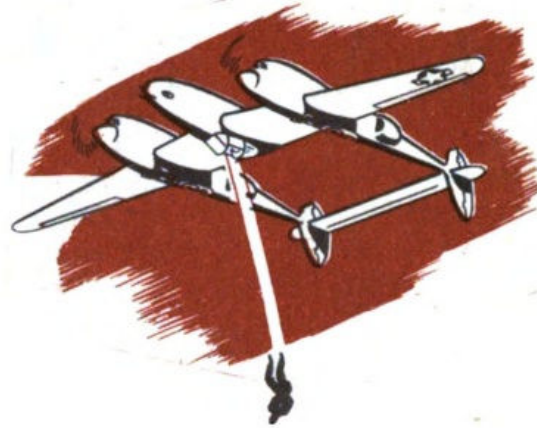

### Sucked out at high speed

If your P-38 is out of control and traveling at a high airspeed, disconnect the oxygen tube and radio equipment, unhook your safety belt, and then release the canopy.

When the canopy is released, the vacuum created in the cockpit sucks you out of the seat and carries you clear of the plane.

If you feel conditions warrant leaving your plane and you have made up your mind to jump, decide which is the best way to get out, and then go.

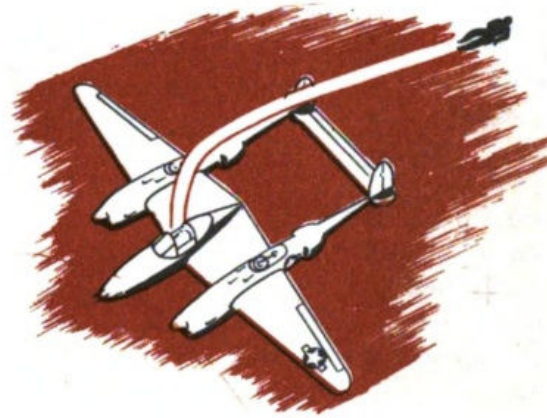

## ICING

If you anticipate icing conditions, or are in heavy rain, turn the pitot heat ON. Water or ice blocking the opening of the pitot tube can give you a false airspeed reading.

The formation of carburetor ice is unlikely in the P-38 because of the injection type carburetors and the heating effect of the turbo-superchargers. It is possible, however, for carburetor ice to form while you are flying at low power in icing conditions.

Remove carburetor ice by increasing power to supercharger range. Close the intercooler shutters (if installed) as far as possible with-

out exceeding the maximum 45°C carburetor temperature.

If you want to add power and not increase your airspeed when flying in limited visibility or turbulence, lower partial flaps or the landing gear or both, as needed.

If icing conditions are present during a landing approach, move the throttles occasionally to prevent ice from freezing them in a closed position. With gear and flaps down, make approach under partial power.

You can remove ice from the windshield by turning the cockpit heat ON and directing the flexible heater tube to the desired point.

## INDEX

	Page		Page
Acrobatics .....	12, 13	Description .....	8, 9
Aileron boost .....	52	Ditching .....	97
Air filters .....	27	Dive flaps .....	52, 79
Airspeed versus altitude .....	76	Dive limits .....	74
Ammeter .....	53, 94, 95	Dives .....	75, 77-79
Armament .....	7, 9, 58-60	Drop tanks .....	38
Arming switch box .....	38	Electrical system .....	53
Armor protection .....	60	Failure .....	94, 95
Bailout .....	11, 98, 99	Engines .....	21
Battery .....	53	Engine failure .....	91
Belly landing .....	96	Escort fighter .....	7
Blindfold test .....	10	Ethylene glycol .....	22
Bomb release .....	38	F-5 .....	7, 9
Brakes .....	46, 68	Camera equipment of .....	61
Camera .....	7, 61	Feathering .....	32, 83
Cannon .....	59	Feathering indicator lights .....	33
Carburetor heat .....	27	Featheritis .....	32
Carburetor icing .....	27, 99	Fighter bomber .....	7
Circuit breakers and fuses .....	53	First flight .....	10
Climb .....	73	Flaps .....	50, 51, 52
Cockpit		Emergency operation of .....	94
Check .....	65	Maneuver .....	52
Explanation .....	10	Flight restrictions .....	74
Heat .....	16	Fuel	
Left side .....	17	Capacity .....	35, 41
Lights .....	62	Consumption .....	41
Main switch box .....	20	Management .....	40
Right side .....	19	Pressure .....	36
Time .....	10	Pumps .....	37, 42, 43
Combat experience .....	7	Primer .....	45
Communications .....	54	Quantity gages .....	37
Compass .....	53	Selectors .....	40
Compressibility .....	77-79	Siphoning .....	40
Controls lock .....	16	Specification .....	64
Control wheel .....	16	Tanks .....	37
Coolant flaps .....	22, 23	Fuel system—modified .....	42, 43
Coolant specifications .....	64	Fuel system—unmodified .....	36
Cooling system .....	22, 23	Generators .....	53
Critical altitude .....	26, 27	Go-around .....	86
Crossfeed and cross suction .....	39	Gun heat .....	61
Crosswind landings .....	86	Gunsight .....	61
Cruise .....	73		

Page	Page		
High altitude fighter.....	7	Demonstration .....	11
History .....	5	Power plant .....	21
Hydraulic system .....	46	Preflight check .....	64
Auxiliary .....	46, 93, 94	Propeller .....	29
Emergency extension .....	46, 93, 94	Automatic constant speed.....	31, 34
Failure .....	93, 94	Check list .....	34
Fluid specifications .....	64	Circuit breakers .....	30
Hand pump .....	19, 49	Manual fixed pitch.....	31, 94, 95
Pressure gage .....	47, 48, 94	Overspeeding .....	33
Icing .....	27, 99	Preflight check .....	34
IFF (Identification, Friend or Foe).....	55	Unfeathering .....	33, 83
Instrument flying .....	89, 90	Warning lights .....	33
Instrument panel .....	18	Radio .....	54, 55
Intercoolers .....	27	Emergency procedures .....	95
Introduction .....	3	Warning system .....	55
Inverter .....	53	Remote compass .....	53
Ladder .....	62	Reverse current relay.....	53
Landing .....	84-86	Rockets .....	59-60
Emergency .....	95-97	Run-up check .....	70
Single engine .....	92	Short field takeoff.....	71
Landing gear .....	48, 49	Single engine .....	82, 83, 91
Down and locked check.....	85	Demonstration .....	14
Emergency extension of.....	46, 93, 94	Landing .....	92, 93
Warning horn .....	48	Practice .....	82
Lighting equipment .....	62	Range .....	92
Low altitude fighter.....	7	Spins .....	80, 81
Low frequency range receiver.....	55	Stalls .....	73
Mach number .....	76, 77	Starting engines .....	66
Machine guns .....	58, 59	In flight .....	83
Manifold pressure regulator.....	27	Stopping engines .....	87
Microphone .....	16, 54	In flight .....	83
Mixture controls .....	28	Supercharger .....	26
Night flying .....	88, 89	Takeoff .....	69, 71
Additional check for .....	65	Taxiing .....	68
Oil dilution .....	25	Throttles .....	26
Oil specification .....	64	Throttle hooks .....	26, 29
Oil system .....	24, 25	Vernier .....	31
Operating data .....	72	VHF Command radio.....	54
Outer wing tanks.....	39, 40, 45	Visual inspection check.....	63
Oxygen system .....	56, 57	Voltage regulator .....	53
Photo-reconnaissance .....	7	Voltmeter .....	53
Piggyback .....	6, 11	Warm-up .....	67
		Water landing .....	97